



**TECNOBENNE®**  
ITALIAN MANUFACTURING

**CATALOGO GENERALE 2019**



**TECNOBENNE<sup>®</sup>**  
ITALIAN MANUFACTURING

**CATALOGO GENERALE 2019**



Tecnobenne è un'azienda specializzata nella progettazione e produzione di attrezzature idrauliche ed elettroidrauliche per il sollevamento e la movimentazione di materiali quali terreno, legname, rottame sia cartaceo che ferroso.

# BENNE POLIPI PINZE FORCHE

Tecnobenne is a company specialized in the design and production of hydraulic and electrohydraulic equipment for lifting and handling materials such as soil timber, paper and ferrous scrap.

## INDICE / INDEX

POLIPI / POLYP GRABS	05
BENNE / CLAMSHELL BUCKETS	17
PINZE / GRABS	29
FORCHE / MULTIPURPOSE FORKS	46
ROTATORI / ROTATORS	56



The Hydraulic polyp-grab is an equipment made with 3/4/5/6 teeth, all of them with independent and synchronized movements, every one of them is actioned by a oleodynamic cylinder. Usually, if not differently specified, polyp grabs have standard on the top the steel lump, all pins are chromated and bushes are in casehardened steel, body and valves are in S355 while bits are made of a wear-resistant material.

Il polipo idraulico è un'attrezzatura di presa costituita da 3/4/5/6 pale a movimento indipendente e sincronizzato, ciascuna delle quali è azionata da un cilindro oleodinamico. Se non specificato diversamente dal cliente, le benne a polipo sono fornite con il massello, tutti i perni sono cromati e le boccole sono in acciaio cementato, il corpo e le valve sono in S355 mentre le punte, sottoposte a consumo, sono in materiale anti usura.

# POLLIPI

POLYP GRABS





# POLIPY POT

**I - Benna idraulica a polipo a cilindri orizzontali per la movimentazione di rottami, rifiuti e materiali vari per gru da camion**

GB - Hydraulic polyp-grab with horizontal cylinders for scrap, waste and different material handling for truck-crane

D - Mehrschalengreifer mit liegenden Zylindern für Schrottschlag und verschiedene Materialien für Ladekräne

F - Grappin à ferraille avec vérins horizontaux pour la manipulation des matériaux divers pour grue de camion

E - Pulpo con cilindros horizontales para el manejo de desechos, residuos y materiales diversos para grúa de camión



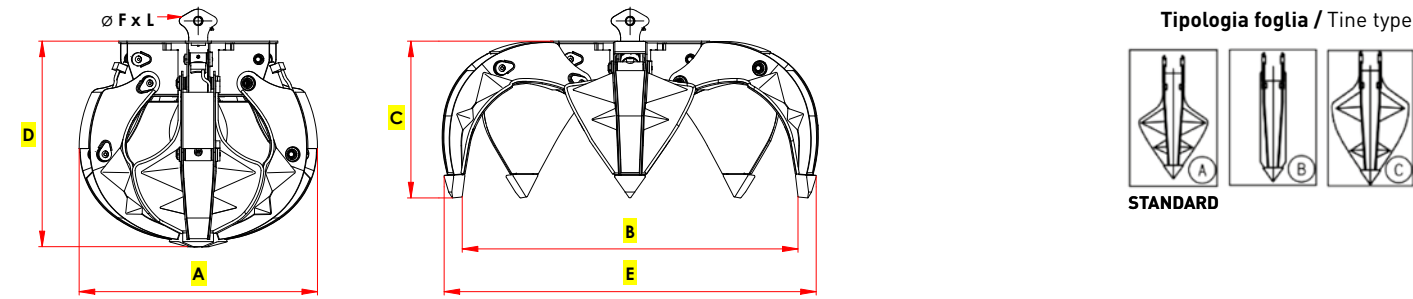

## DISEGNO TECNICO / TECHNICAL DRAWING



 Portata gru a braccio sfilato / Lifting capacity at the end of boom

 Peso escavatore / Excavator weight

Modello Type	Denti Teeth nr.	Capacità Capacity Lt	Portata Load kg	Peso Weight kg	Pressione Pressure Max bar	Portata olio Oil flow Lt/min			A	B	C	D	E	FxL
							Ton.	Ton.	mm	mm	mm	mm	mm	mm
POT 80/4	4	90	750	81	200	20	0,15-0,3	1,0-2,0	650	1010	430	580	1090	25x30
POT 95/4	4	110	900	105	250	25	0,25-0,5	2,0-3,0	730	1130	480	650	1230	25x30
POT 95/5	5	110	1500	118	250	30	0,25-0,5	2,0-3,0	730	1130	480	650	1230	25x30
POT 115/4	4	120	900	112	250	25	0,3-0,6	2,5-4,0	743	1240	497	700	1340	25x30
POT 115/5	5	120	1500	130	250	30	0,3-0,6	2,5-4,0	743	1240	497	700	1340	25x30
POT 130/4	4	160	1500	230	250	50	0,3-0,8	3,0-5,0	900	1300	550	750	1400	30x60
POT 140/5	5	160	2000	265	250	60	0,4-1,0	3,0-5,0	900	1300	550	750	1400	30x60
POT 150/6	6	160	2500	310	250	75	0,4-1,0	3,0-5,0	900	1300	550	750	1400	30x60
POT 170/4	4	205	1500	250	250	50	0,5-1,1	3,0-6,0	920	1560	600	890	1650	30x60
POT 210/5	5	205	2000	275	250	60	0,6-1,2	3,0-6,0	920	1560	600	890	1650	30x60
POT 220/6	6	205	2500	320	250	75	0,6-1,2	3,0-6,0	920	1560	600	890	1650	30x60
POT 250/4*	4	270	2000	310	250	60	0,7-1,3	4,0-7,0	1000	1490	650	900	1640	32x80
POT 255/5*	5	270	2500	350	250	70	0,8-1,6	4,0-7,0	1000	1490	650	900	1640	32x80
POT 265/6*	6	270	3000	390	250	85	0,8-1,6	4,0-7,0	1000	1490	650	900	1640	32x80
POT 290/4*	4	325	2500	375	250	60	1,0-2,0	6,0-9,0	1120	1630	680	930	1760	32x80
POT 295/5*	5	325	3000	415	250	70	1,0-2,0	6,0-9,0	1120	1630	680	930	1760	32x80
POT 325/6*	6	325	3000	460	250	85	1,0-2,0	6,0-9,0	1120	1630	680	930	1760	32x80
POT 390/4*	4	400	2500	420	250	60	1,0-3,0	7,0-12	1240	1780	760	970	1940	32x80
POT 395/5*	5	400	3000	450	250	70	1,0-3,0	7,0-12	1240	1780	760	970	1940	32x80
POT 405/6*	6	400	3000	520	250	85	1,0-3,0	7,0-12	1240	1780	760	970	1940	32x80

\* = A richiesta anche nella versione super rinforzato / Available also in the super strengthened version.

6

# POLIPY POT S

**I - Benna idraulica a polipo con grande capacità di apertura e minimo ingombro a riposo**

GB - Hydraulic polyp-grab with a great capacity of opening and a small footprint at rest

D - Hydraulikmehrschalengreifer mit großer Öffnungsweite und niedriger Bauweise

F - Grappin à ferraille hydraulique avec une grande capacité d'ouverture et un encombrement réduit au repos

E - Pulpo hidráulico con una gran capacidad de apertura y una pequeña huella en reposo

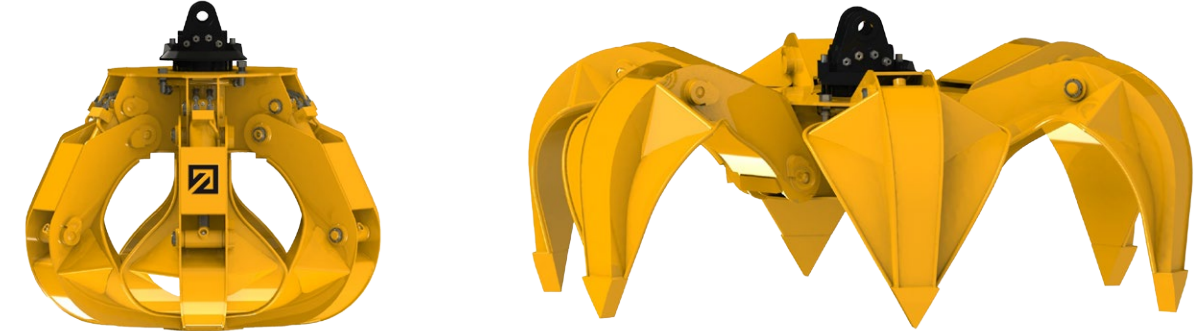

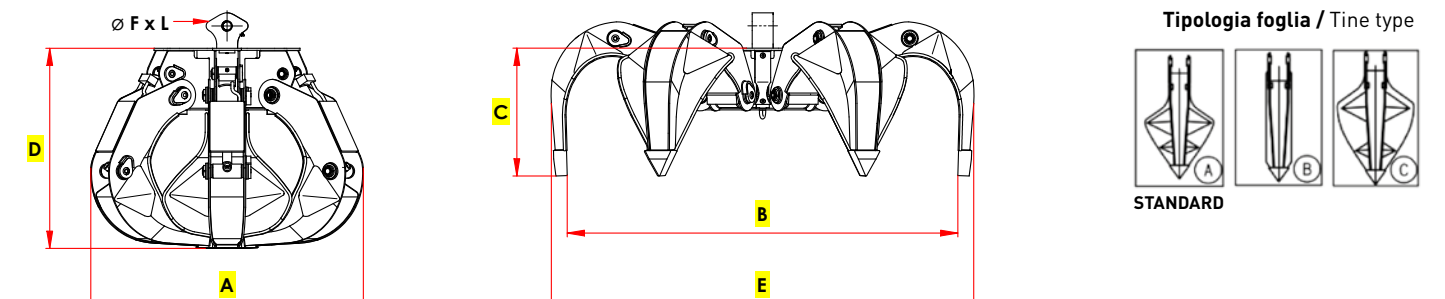

## DISEGNO TECNICO / TECHNICAL DRAWING



 Portata gru a braccio sfilato / Lifting capacity at the end of boom

 Peso escavatore / Excavator weight

Modello Type	Denti Teeth nr.	Capacità Capacity Lt	Portata Load kg	Peso Weight kg	Pressione Pressure Max bar	Portata olio Oil flow Lt/min			A	B	C	D	E	FxL
							Ton.	Ton.	mm	mm	mm	mm	mm	mm
POT S 275/6	6	275	3000	370	250	85	0,8-1,6	4,0-7,0	1120	1490	500	760	1600	32x80
POT S 315/6	6	315	3000	430	250	85	1,0-2,0	6,0-9,0	1200	1650	570	860	1800	32x80

I dati possono essere variati senza preavviso. / Technical data can be revised without prior notice.

7

# POLIPY POT H

## I - Benna idraulica a polipo a cilindri orizzontali ideale per caricatore ripieghevole a Z

GB - Hydraulic polyp-grab with horizontal cylinders ideal for Z - collapsible truck crane

D - Hydraulikmehrschalengreifer mit liegenden Zylindern, ideal für zusammenfaltbare Z- Ladekräne

F - Grappin à ferraille hydraulique avec vérins horizontaux idéal pour grue de camion repliable à Z

E - Pulpo hidráulico con cilindros horizontales ideal para camión grúa plegable a Z



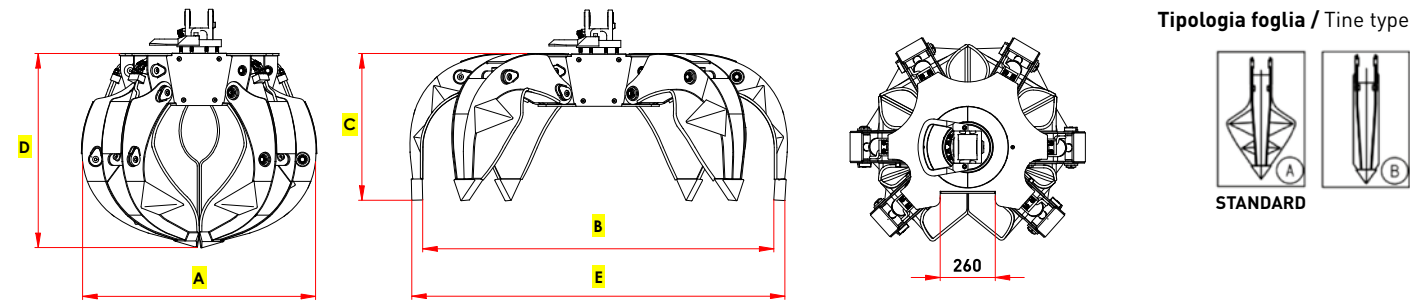

### DISEGNO TECNICO / TECHNICAL DRAWING



 Portata gru a braccio sfilato / Lifting capacity at the end of boom

 Peso escavatore / Excavator weight

Modello Type	Denti Teeth nr.	Capacità Capacity Lt	Portata Load kg	Peso Weight kg	Pressione Pressure Max bar	Portata olio Oil flow Lt/min	 Ton.	 Ton.	A mm	B mm	C mm	D mm	E mm
POT H 280/5	5	280	3000	385	250	60	0,8-2,0	-	1070	1580	670	870	1710
POT H 280/6	6	280	3000	425	250	85	0,8-2,0	-	1070	1580	670	870	1710

# POLIPY POT P

## I - Benna idraulica a polipo a cilindri orizzontali per escavatore

GB - Hydraulic polyp-grab with horizontal cylinders for excavator

D - Hydraulikmehrschalengreifer mit liegenden Zylindern für Bagger

F - Grappin à ferraille avec vérins horizontaux pour pelle

E - Pulpo con cilindros horizontales para excavadora

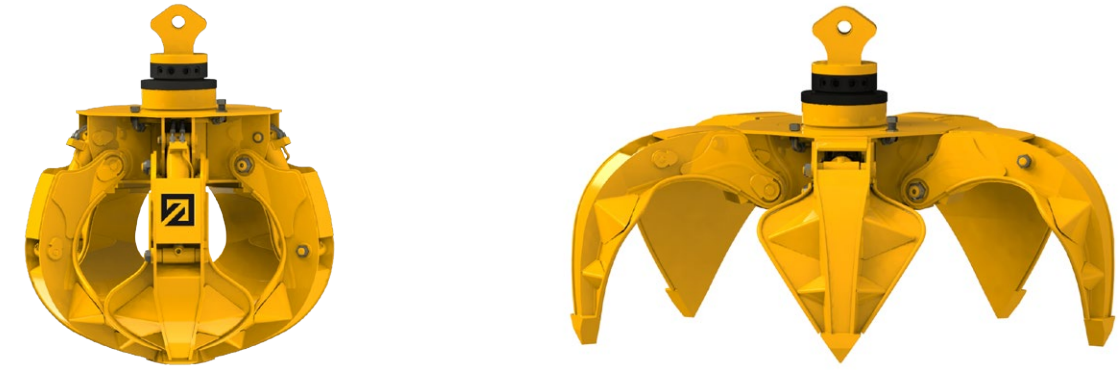

### DISEGNO TECNICO / TECHNICAL DRAWING

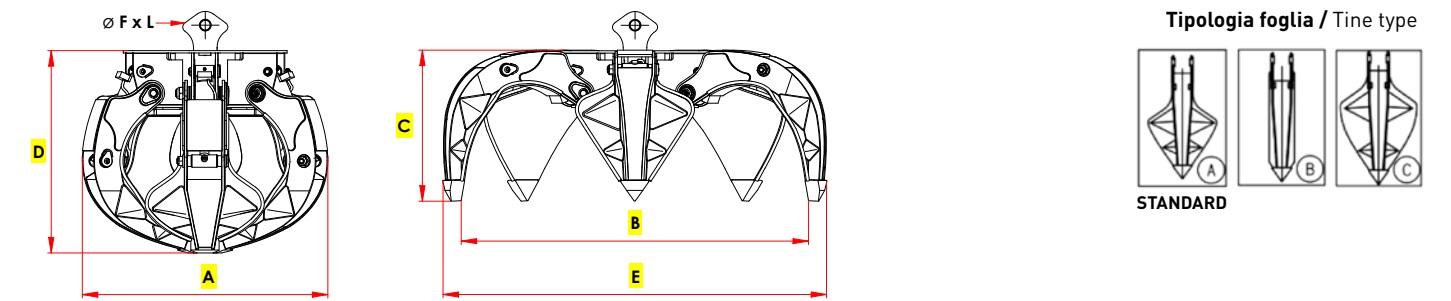

 Portata gru a braccio sfilato / Lifting capacity at the end of boom

 Peso escavatore / Excavator weight

Modello Type	Denti Teeth nr.	Capacità Capacity Lt	Portata Load kg	Peso Weight kg	Pressione Pressure Max bar	Portata olio Oil flow Lt/min	 Ton.	 Ton.	A mm	B mm	C mm	D mm	E mm	FxL mm
POT 405/5 P	5	400	5000	800	250	100	-	13-18	1250	1860	760	1020	2010	50x100
POT 415/6 P	6	400	5000	890	250	120	-	13-20	1250	1860	760	1020	2010	50x100
POT 505/5 P	5	500	5000	815	250	100	-	15-22	1300	1930	780	1050	2080	50x100
POT 515/6 P	6	500	5000	910	250	120	-	15-22	1300	1930	780	1050	2080	50x100
POT 605/5 P	5	600	5000	830	250	100	-	18-26	1350	2000	815	1090	2165	50x100
POT 615/6 P	6	600	5000	930	250	120	-	18-26	1350	2000	815	1090	2165	50x100
POT 805/5 P	5	800	6000	1150	250	100	-	25-35	1450	2160	880	1180	2330	50x100
POT 815/6 P	6	800	6000	1260	250	120	-	25-35	1450	2160	880	1180	2330	50x100

# POLIPI POT M

## I - Benna idraulica a polipo ideata per la movimentazione di massi e rocce

GB - Polyp-grab for rocks handling

D- Drei-Schalen-Greifer für Gesteinblöcke, Geröll und Felsen

F - Grappin conçu pour le mouvement et le tri de pierres, roches et blocs

E - Pulpo diseñado para el manejo de los cantos rodados y rocas



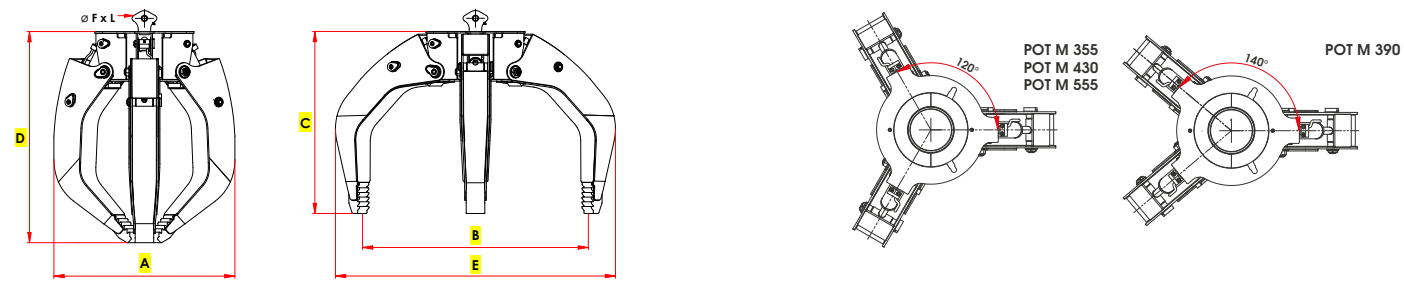

### DISEGNO TECNICO / TECHNICAL DRAWING



 Portata gru a braccio sfilato / Lifting capacity at the end of boom

 Peso escavatore / Excavator weight

Modello Type	Denti Teeth nr.	Capacità Capacity Lt	Portata Load kg	Peso Weight kg	Pressione Pressure Max bar	Portata olio Oil flow Lt/min			A mm	B mm	C mm	D mm	E mm	FxL mm
POT M 355/3	3	355	3000	420	250	50	1,0-2,0	7,0-12	1250	1650	1180	1360	1980	32x80
POT M 390/3	3	390	3500	440	250	50	1,0-2,0	7,0-12	1350	1750	1180	1360	2080	32x80
POT M 430/3	3	430	4000	520	250	70	1,5-2,5	10-17	1330	1730	1180	1360	2070	32x80
POT M 555/3	3	550	5000	900	250	70	2,0-3,0	17-20	1450	1900	1360	1570	2300	50x100

# POLIPI PVT

## I - Benna idraulica a polipo a cilindri verticali per rottami, rifiuti e materiali vari per gru da camion

GB - Hydraulic polyp-grab with vertical cylinders for scrap, waste and different material handling for truck-crane

D - Hydraulikmehrschalengreifer mit senkrechten Zylindern für Schrott und verschiedene Materialien für Ladekräne

F - Grappin à ferraille avec vérins verticaux pour débris, déchets et matériaux différents pour grue de camion

E - Pulpo con cilindros verticales de chatarra, residuos y otros materiales para grúa sobre camión



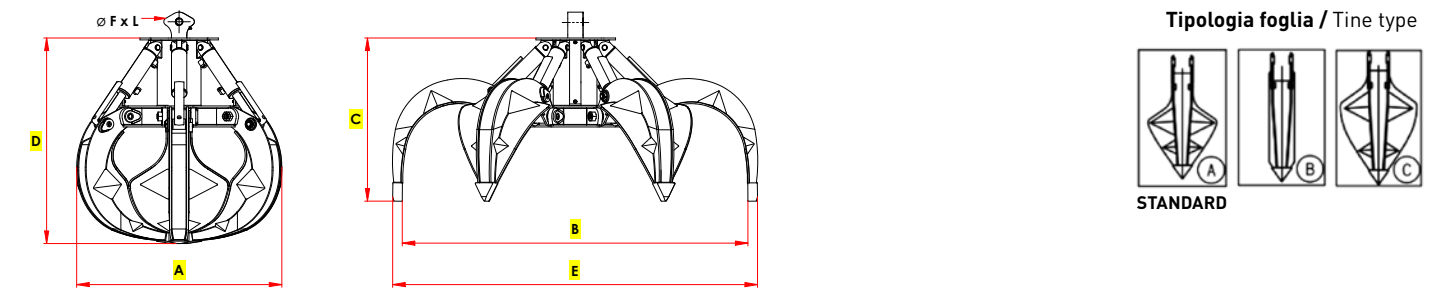

### DISEGNO TECNICO / TECHNICAL DRAWING



 Portata gru a braccio sfilato / Lifting capacity at the end of boom

 Peso escavatore / Excavator weight

Modello Type	Denti Teeth nr.	Capacità Capacity Lt	Portata Load kg	Peso Weight kg	Pressione Pressure Max bar	Portata olio Oil flow Lt/min			A mm	B mm	C mm	D mm	E mm	FxL mm
PVT 155/5	5	155	1500	240	250	60	0,5-1,0	3,0-5,0	900	1360	760	900	1440	30x60
PVT 260/6	6	255	2500	330	250	70	0,7-1,5	4,0-7,0	1000	1480	750	930	1580	30x60
PVT 370/6	6	370	3000	400	250	90	1,0-2,0	6,0-10	1120	1600	850	970	1700	32x80
PVT 490/6	6	490	3500	500	250	90	1,5-3,0	7,0-12	1180	1800	860	1070	1900	32x80



# POLIFI PVT P

## I - Benna idraulica a polipo a cilindri verticali per rottami, rifiuti e materiali vari per escavatore

- GB - Hydraulic polyp-grab with vertical cylinders for scrap, waste and different material handling for excavator  
 D - Hydraulikmehrschalengreifer mit senkrechten Zylindern für Schrott und verschiedene Materialien für Bagger  
 F - Grappin à ferraille avec vérins verticaux pour débris, déchets et matériaux différents pour pelle  
 E - Pulpo con cilindros verticales para chatarra, residuos y otros materiales, para excavadora



### DISEGNO TECNICO / TECHNICAL DRAWING

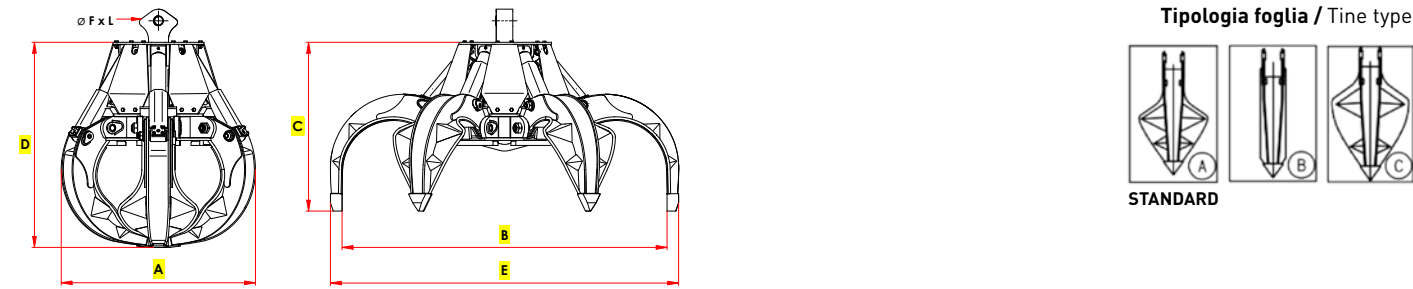

Portata gru a braccio sfilato / Lifting capacity at the end of boom

Peso escavatore / Excavator weight

Modello Type	Denti Teeth nr.	Capacità Capacity Lt	Portata Load kg	Peso Weight kg	Pressione Pressure Max bar	Portata olio Oil flow Lt/min			A mm	B mm	C mm	D mm	E mm	FxL mm
PVT 500/5 P	5	500	4000	900	250	100	-	15-20	1215	1860	970	1170	1960	50x100
PVT 510/6 P	6	500	5000	1000	250	120	-	15-22	1215	1860	970	1170	1960	50x100
PVT 600/5 P	5	600	5000	1100	250	125	-	18-25	1280	1960	1020	1230	2100	50x100
PVT 610/6 P	6	600	6000	1200	250	150	-	18-27	1280	1960	1020	1230	2100	50x100
PVT 800/5 P	5	800	7000	1700	250	170	-	24-35	1625	2450	1280	1575	2630	50x100
PVT 810/6 P	6	800	8000	1800	250	200	-	24-37	1625	2450	1280	1575	2630	50x100

# POLIFI PVT M

## I - Benna idraulica a polipo con magnete incorporato

- GB - Hydraulic polyp-grab with integrated magnet  
 D - Hydraulikmehrschalengreifer mit eingebautem Magnet  
 F - Grappin à ferraille avec aimant intégré  
 D - Pulpo con imán integrado



### DISEGNO TECNICO / TECHNICAL DRAWING

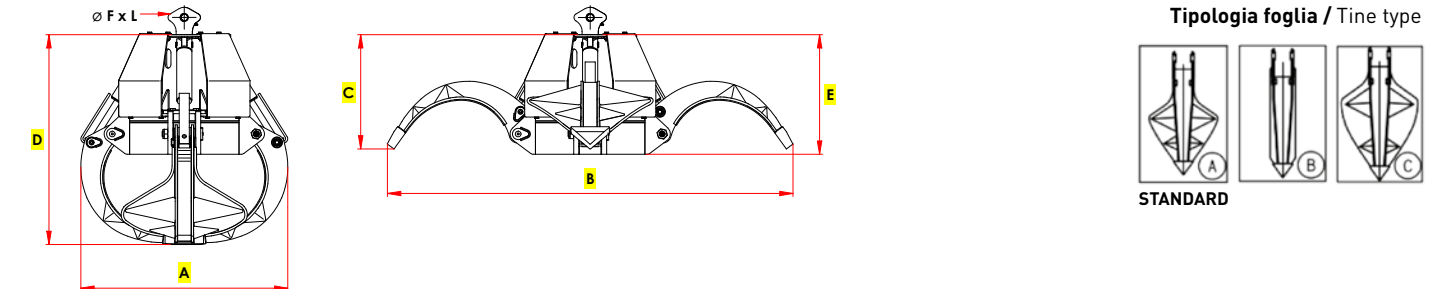

Portata gru a braccio sfilato / Lifting capacity at the end of boom

Peso escavatore / Excavator weight

Modello Type	Denti Teeth nr.	Capacità Capacity Lt	Portata Load kg	Peso Weight kg	Pressione Pressure Max bar	Portata olio Oil flow Lt/min						A mm	B mm	C mm	D mm	E mm	FxL mm
PVT M 260/4	4	260	2000	570	250	70	0,7-1,6	4,0-7,0	0,5	24	2000	1020	2000	560	1030	590	32x80
PVT M 260/5	5	260	2000	595	250	90	0,7-1,6	4,0-8,0	0,5	24	2000	1020	2000	560	1030	590	32x80

#### Accessori

- Comando elettrico completo di pulsantiera con protezione IP55
- Dimensioni: 200x300x400 mm
- Cavo elettrico (2x6 mm<sup>2</sup>)
- Avvolgi cavo corsa max 12 metri

#### Accessories

- Electric control with button panel with protection IP55
- Dimensions: 200x300x400 mm
- Electric cable (2x6 mm<sup>2</sup>)
- Cable winding-stroke max 12 metres

#### Zubehör

- Elektrische Steuerung mit Schalttafel mit Schutzvorrichtung IP55
- Abmessungen: 200x300x400 mm
- Elektrisches Stromkabel (2x6 mm<sup>2</sup>)
- Kabelwickler-Hub max 12 Metern

#### Accessoires

- Commande électrique avec tableau de commande équipé de protection IP55
- Dimensions: 200x300x400 mm
- Câble électrique (2x6 mm<sup>2</sup>)
- Enrouleur de câble - course maximum 12 mètres

#### Accesorios

- Control eléctrico y panel de mando con protección IP55
- Dimensiones: 200x300x400 mm
- Cable eléctrico (2x6 mm<sup>2</sup>)
- Enrollador de cable - carrera max 12 metros



# POLIPI PLOT

## I - Benna a polipo per la raccolta di legna da ardere

GB - Polyp grab for handling firewood and sawn timber

D - Mehrschalengreifer für die Sammlung von Brennholz

F - Grappin pour le chargement de bois de chauffage

E - Pulpo para recogida de leña



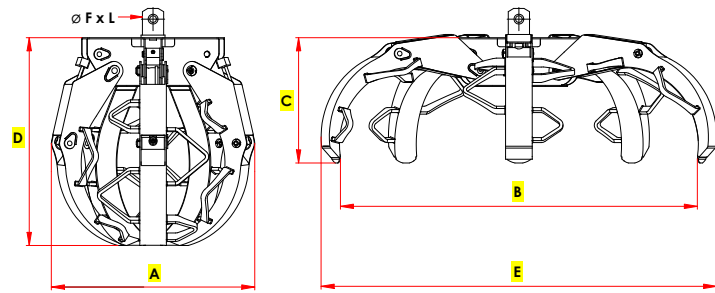

## DISEGNO TECNICO / TECHNICAL DRAWING



Portata gru a braccio sfilato / Lifting capacity at the end of boom



Peso escavatore / Excavator weight

Modello Type	Denti Teeth nr.	Capacità Capacity Lt	Portata Load kg	Peso Weight kg	Pressione Pressure Max bar	Portata olio Oil flow Lt/min			A	B	C	D	E	FxL
							Ton.	Ton.	mm	mm	mm	mm	mm	mm
<b>PLOT 120/5</b>	5	120	1000	130	250	30	0,25-0,5	1,5-3,0	780	1400	500	780	1520	25x30
<b>PLOT 285/5</b>	5	285	1500	220	250	60	0,5-1,1	3,0-6,0	950	1805	645	1100	1930	30x40
<b>PLOT 440/5</b>	5	440	2500	393	250	70	1,0-3,0	7,0-12	1140	2330	712	1260	2470	32x80

The hydraulic clamshell bucket is an equipment composed of two synchronized shells, moved by an hydraulic cylinder. Its body is made of S355, bushes are in casehardened steel while parts more used (such as blades) are made of a wear-resistant material. Clamshell buckets are available with one or two cylinders, that can be horizontal or vertical. Clamshell buckets could be used for different materials loading and also for digging.

La benna idraulica è un'attrezzatura di presa costituita da 2 valve a movimento sincronizzato, azionate da un cilindro oleodinamico. Il corpo delle nostre benne bivalve è costruito in S355, le boccole sono in acciaio cementato, mentre le parti più sottoposte a consumo (le lame ad esempio) sono in materiale anti usura. Le benne sono disponibili con uno o due cilindri: questi pistoni idraulici possono essere orizzontali o verticali e le attrezzature vengono usate per carico e scarico di materiali differenti o per scavo.

# BENNE

CLAMSHELL BUCKETS





# BENNE BOTL M

## I - Benna bivalve a cilindro orizzontale per carico e scarico di materiali diversi

GB - Clamshell bucket with horizontal cylinder for loading and unloading different materials

D - Zweischalengreifer mit liegendem Zylinder für den Umschlag von verschiedenen Werkstoffen

F - Benne preneuse à vérin horizontal pour le chargement et déchargement des matériaux différents

E - Cuchara bivalva con cilindro horizontal para carga y descarga de materiales diversos

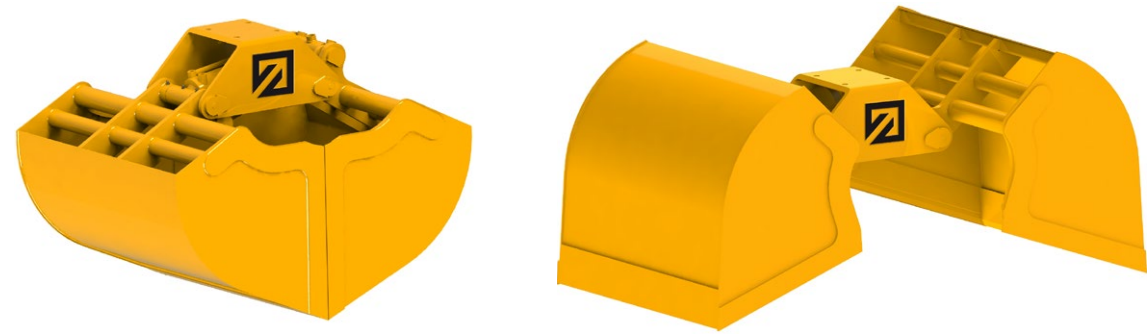

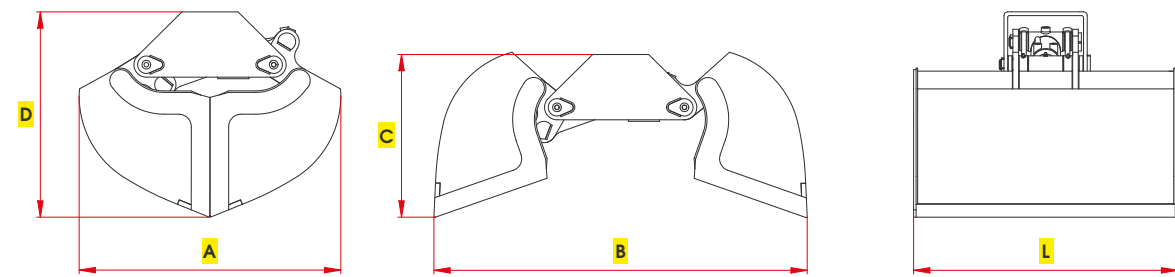

### DISEGNO TECNICO / TECHNICAL DRAWING



 Portata gru a braccio sfilato / Lifting capacity at the end of boom

 Peso escavatore / Excavator weight

Modello Type	Capacità Capacity Lt	Portata Load kg	Peso Weight kg	Pressione Pressure Max bar	Portata olio Oil flow Lt/min	 Ton.	 Ton.	A mm	B mm	C mm	D mm	L mm
<b>BOTL M 35</b>	35	100	32	200	10	0,1-0,3	0,8-1,0	456	624	304	357	305
<b>BOTL M 50</b>	50	150	52	200	15	0,2-0,4	0,8-1,2	626	894	390	492	330
<b>BOTL M 91</b>	90	200	85	200	15	0,2-0,5	1,0-1,5	770	1100	480	605	350
<b>BOTL M 125</b>	125	250	134	200	20	0,3-0,7	1,2-1,7	840	1200	523	660	450
<b>BOTL M 155</b>	155	350	143	200	20	0,4-0,8	1,2-2,0	840	1200	523	660	550
<b>BOTL M 175</b>	175	350	152	200	20	0,5-0,9	1,5-2,2	840	1200	523	660	650
<b>BOTL M 205</b>	205	450	161	200	20	0,6-1,0	1,8-2,5	840	1200	523	660	750
<b>BOTL M 225</b>	225	450	170	200	20	0,7-1,2	1,8-3,0	840	1200	523	660	850
<b>BOTL M 320</b>	320	700	208	200	20	0,9-1,3	2,5-3,5	1040	1430	565	780	800
<b>BOTL M 360</b>	360	700	220	200	20	0,9-1,5	2,5-4,0	1040	1430	565	780	900
<b>BOTL M 400</b>	400	700	232	200	20	1,0-1,6	3,0-5,0	1040	1430	565	780	1000
<b>BOTL M 500</b>	520	1000	315	200	30	1,0-2,0	4,0-7,0	1200	1640	660	905	1000
<b>BOTL M 600</b>	620	1000	343	200	30	1,0-2,0	4,0-7,0	1200	1640	660	905	1200

# BENNE BOTL MR

## I - Benna bivalve a cilindro orizzontale per rifiuti e manutenzione spazi verdi - Pareti amovibili a richiesta

GB - Clamshell bucket with horizontal cylinder for waste and green spaces maintenance - Removable side-walls by request

D - Zweischalengreifer mit liegendem Zylinder für Müll und Grünflächenunterhaltung - Abnehmbare Seitenschalen auf Wunsch

F - Benne preneuse à vérin horizontal pour le chargement des déchets et l'entretien d'espaces verts - Parois amovibles sur demande

E - Cuchara bivalva con cilindro horizontal para desperdicios y mantenimiento de espacios verdes - Paredes laterales amovibles a demanda

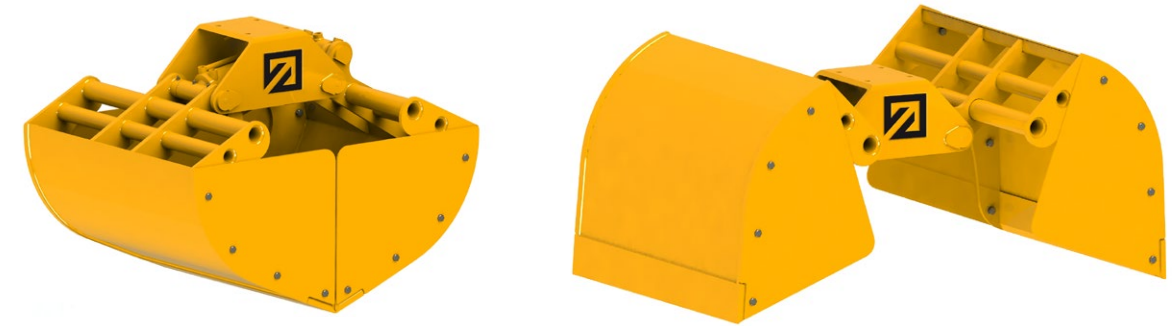

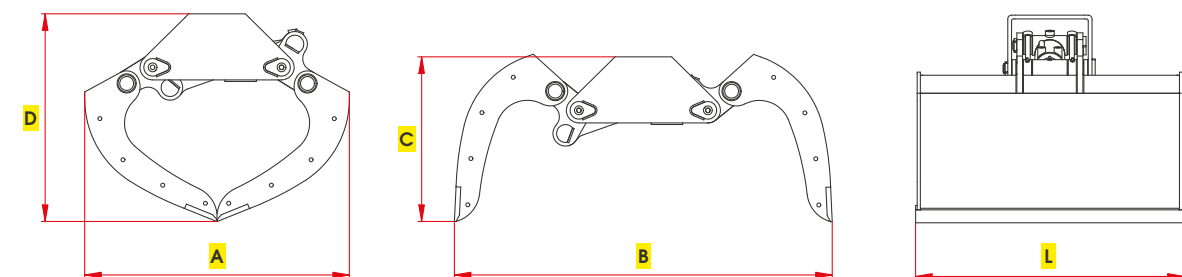

### DISEGNO TECNICO / TECHNICAL DRAWING



 Portata gru a braccio sfilato / Lifting capacity at the end of boom

 Peso escavatore / Excavator weight

Modello Type	Capacità Capacity Lt	Portata Load kg	Peso Weight kg	Pressione Pressure Max bar	Portata olio Oil flow Lt/min	 Ton.	 Ton.	A mm	B mm	C mm	D mm	L mm
<b>BOTL MR 35</b>	35	100	32	200	10	0,1-0,3	0,8-1,0	456	624	304	357	305
<b>BOTL MR 50</b>	50	150	52	200	15	0,2-0,4	0,8-1,2	626	894	390	492	330
<b>BOTL MR 91</b>	90	200	85	200	15	0,2-0,5	1,0-1,5	770	1100	480	605	350
<b>BOTL MR 125</b>	125	250	134	200	20	0,3-0,7	1,2-1,7	840	1200	523	660	450
<b>BOTL MR 155</b>	155	350	143	200	20	0,4-0,8	1,2-2,0	840	1200	523	660	550
<b>BOTL MR 175</b>	175	350	152	200	20	0,5-0,9	1,5-2,2	840	1200	523	660	650
<b>BOTL MR 205</b>	205	450	161	200	20	0,6-1,0	1,8-2,5	840	1200	523	660	750
<b>BOTL MR 225</b>	225	450	170	200	20	0,7-1,2	1,8-3,0	840	1200	523	660	850
<b>BOTL MR 320</b>	320	700	208	200	20	0,9-1,3	2,5-3,5	1040	1430	565	780	800
<b>BOTL MR 360</b>	360	700	220	200	20	0,9-1,5	2,5-4,0	1040	1430	565	780	900
<b>BOTL MR 400</b>	400	700	232	200	20	1,0-1,6	3,0-5,0	1040	1430	565	780	1000
<b>BOTL MR 500</b>	520	1000	315	200	30	1,0-2,0	4,0-7,0	1200	1640	660	905	1000
<b>BOTL MR 600</b>	620	1000	343	200	30	1,0-2,0	4,0-7,0	1200	1640	660	905	1200

# BENNE BOT L

## I - Benna bivalve a cilindro orizzontale con grande apertura e capacità per carico di materiali differenti

GB - Clamshell bucket with horizontal cylinder with a large opening and capacity for handling different materials

D - Zweischalengreifer mit liegendem Zylinder mit großer Öffnungsweite und Inhalt für verschiedenen Materialumschlag

F - Benne preneuse à vérin horizontal de grande ouverture et capacité pour le chargement et déchargement des plusieurs matériaux

E - Cuchara bivalva con cilindro horizontal con gran apertura y capacidad para carga y descarga de materiales diversos

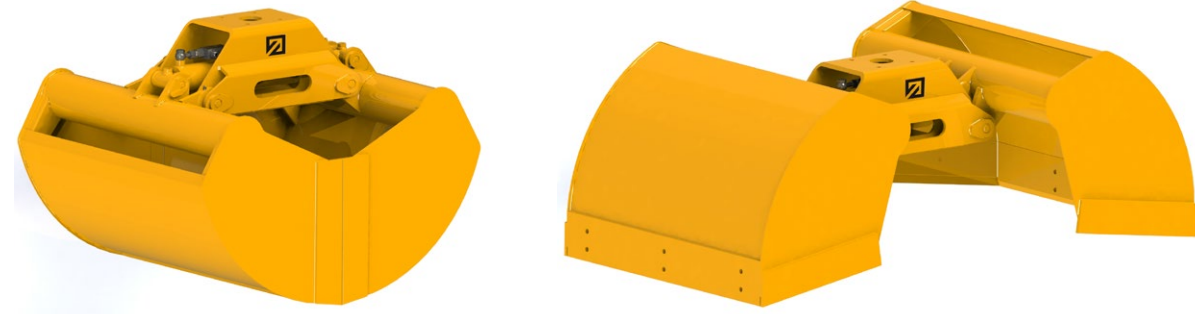

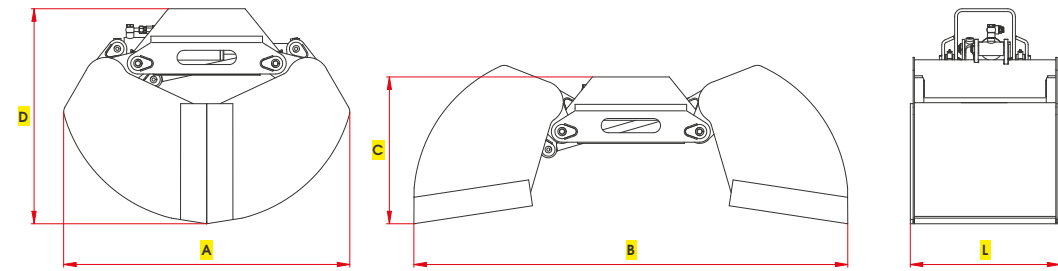

### DISEGNO TECNICO / TECHNICAL DRAWING



 Portata gru a braccio sfilato / Lifting capacity at the end of boom

 Peso escavatore / Excavator weight

Modello Type	Capacità Capacity	Portata Load	Peso Weight	Pressione Pressure	Portata olio Oil flow			A	B	C	D	L
	Lt	kg	kg	Max bar	Lt/min	Ton.	Ton.	mm	mm	mm	mm	mm
<b>BOT L 150</b>	150	1000	260	200	50	0,6-1,5	4,0-7,0	1206	1830	620	900	360
<b>BOT L 210</b>	220	1000	269	200	50	0,6-1,8	4,0-7,0	1206	1830	620	900	430
<b>BOT L 300</b>	300	1300	287	200	50	0,8-2,0	4,0-7,0	1206	1830	620	900	630
<b>BOT L 400</b>	400	1300	296	200	50	0,8-2,0	4,0-7,0	1206	1830	620	900	730
<b>BOT L 450</b>	460	1300	305	200	50	0,8-2,2	4,0-7,0	1206	1830	620	900	830
<b>BOT L 590</b>	580	1300	323	200	50	0,8-2,4	4,0-8,0	1206	1830	620	900	1030

# BENNE BOT R

## I - Benna bivalve "multi uso" con cilindro orizzontale per carico di materiali e rifiuti

GB - "Multi-purpose" clamshell bucket with horizontal cylinder for different bulk material

D - Zweischalengreifer mit liegendem Zylinder für den Umschlag von verschiedenen Werkstoffen

F - Benne preneuse multifonction à vérin horizontal pour le chargement et le déchargement des tous matériaux

E - Cuchara bivalva de usos múltiples con cilindro horizontal para la carga de materiales diversos



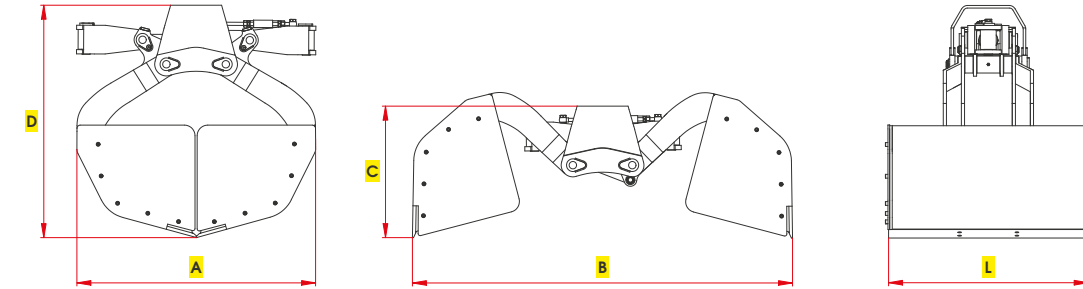

### DISEGNO TECNICO / TECHNICAL DRAWING



 Portata gru a braccio sfilato / Lifting capacity at the end of boom

 Peso escavatore / Excavator weight

Modello Type	Capacità Capacity	Portata Load	Peso Weight	Pressione Pressure	Portata olio Oil flow			A	B	C	D	L
	Lt	kg	kg	Max bar	Lt/min	Ton.	Ton.	mm	mm	mm	mm	mm
<b>BOT R 250</b>	280	1000	310	200	60	0,8-2,0	4,0-7,0	1130	1780	620	1100	530
<b>BOT R 300</b>	330	1500	322	200	60	0,8-2,2	4,0-7,0	1130	1780	620	1100	630
<b>BOT R 450</b>	430	1500	334	200	60	0,8-2,4	4,0-7,0	1130	1780	620	1100	830
<b>BOT R 500</b>	530	1500	346	200	60	1,0-2,8	4,0-8,0	1130	1780	620	1100	930

# BENNE BOT S

## I - Benna bivalve a cilindro orizzontale per carico, scarico e scavi leggeri\*

GB - Clamshell bucket with horizontal cylinder for loading, unloading and light digging\*

D - Zweischalengreifer mit liegendem Zylinder für Laden, Abladen und leichte Gräben\*

F - Benne preneuse avec vérin horizontal pour tous travaux de chargement, déchargement, creusage et terrassement léger\*

E - Cuchara bivalva con cilindro horizontal para carga, descarga y excavaciones ligeras\*

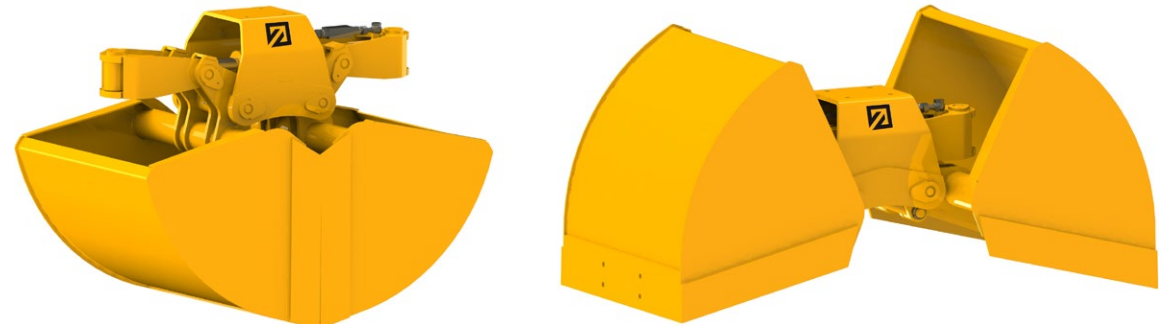

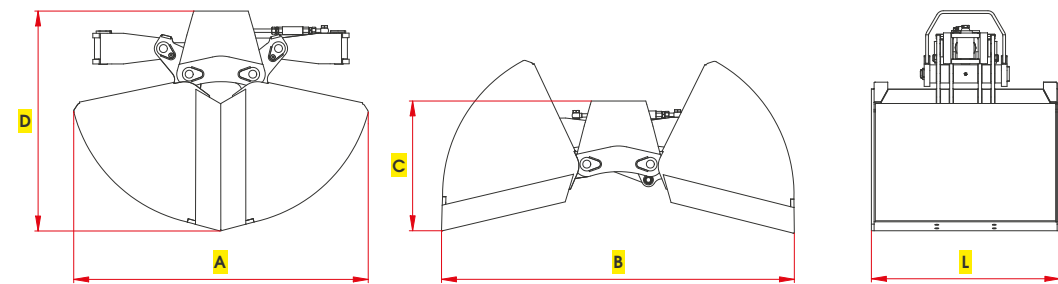

### DISEGNO TECNICO / TECHNICAL DRAWING



 Portata gru a braccio sfilato / Lifting capacity at the end of boom

 Peso escavatore / Excavator weight

Modello Type	Capacità Capacity Lt	Portata Load kg	Peso Weight kg	Pressione Pressure Max bar	Portata olio Oil flow Lt/min	 Ton.	 Ton.	A mm	B mm	C mm	D mm	L mm
<b>BOT S 205</b>	200	1000	260	200	60	0,6-1,5	4,0-7,0	1300	1550	580	970	430
<b>BOT S 255</b>	250	1000	280	200	60	0,8-2,0	4,0-7,0	1300	1550	580	970	530
<b>BOT S 305</b>	300	1500	300	200	60	0,8-2,4	4,0-7,0	1300	1550	580	970	630
<b>BOT S 405</b>	400	1500	320	200	60	1,0-2,8	4,0-7,0	1300	1550	580	970	730
<b>BOT S 505</b>	500	1500	340	200	60	1,0-2,8	4,0-8,0	1300	1550	580	970	830

\*Espulsore a richiesta - Ejector by request - Auswerfer auf Wunsch - Racleur sur demande - Expulsor a demanda.

# BENNE BOT 2

## I - Benna bivalve con due cilindri orizzontali con grande capacità di carico, particolarmente adatta per impieghi gravosi

GB - Clamshell bucket with two horizontal cylinders with great intake, especially suitable for heavy duty works

D - Schüttgutgreifer mit zwei liegenden Zylindern mit großem Inhalt, besonders für schweren Einsatz geeignet

F - Benne preneuse à deux vérins horizontaux de grande capacité, particulièrement recommandée pour les gros travaux

E - Cuchara bivalva con dos cilindros horizontales de gran capacidad, particularmente adecuada para trabajos gravosos

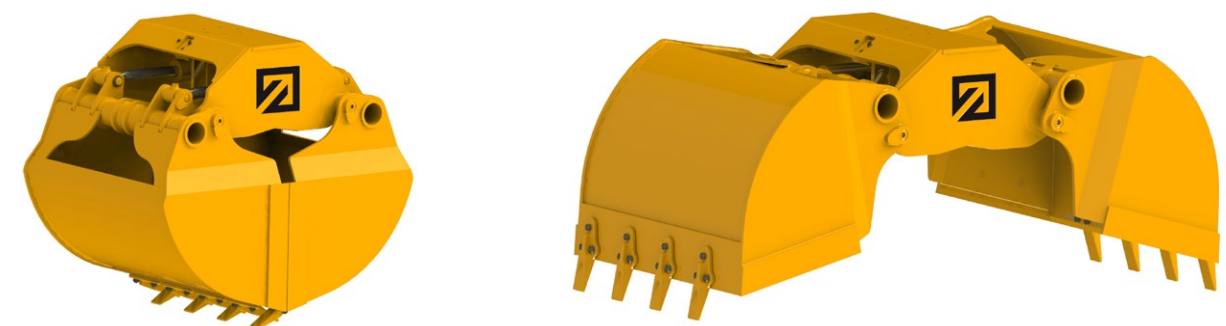

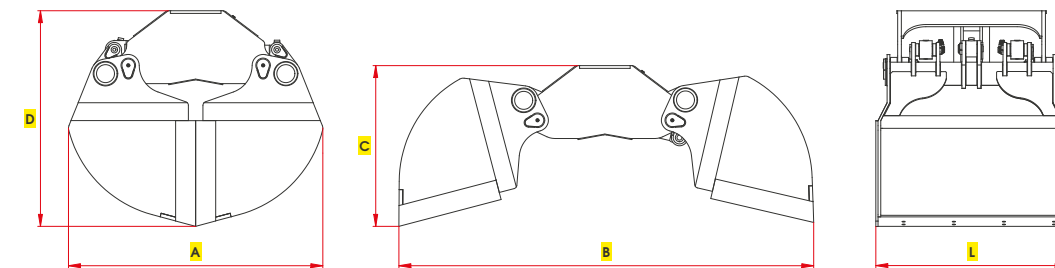

### DISEGNO TECNICO / TECHNICAL DRAWING



 Portata gru a braccio sfilato / Lifting capacity at the end of boom

 Peso escavatore / Excavator weight

Modello Type	Capacità Capacity Lt	Portata Load kg	Peso Weight kg	Pressione Pressure Max bar	Portata olio Oil flow Lt/min	 Ton.	 Ton.	A mm	B mm	C mm	D mm	L mm
<b>BOT2 400</b>	400	2000	430	250	50	1,0-2,5	6,0-12	1140	1840	710	950	840
<b>BOT2 500</b>	500	2500	460	250	50	1,5-2,5	6,0-12	1140	1840	710	950	1040
<b>BOT2 790</b>	770	3000	615	250	50	1,5-2,8	8,5-15	1140	1840	710	950	1540
<b>BOT2 800 P</b>	750	2500	710	250	100	1,8-2,8	10-18	1400	2270	880	1180	860
<b>BOT2 1000 P</b>	860	3000	850	250	100	2,0-3,0	12-20	1400	2270	880	1180	1050
<b>BOT2 1200 P</b>	1020	3500	880	250	100	2,0-3,0	15-25	1400	2270	880	1180	1250
<b>BOT2 1500 P</b>	1230	4000	1100	250	100	2,5-3,5	15-25	1400	2270	880	1180	1500
<b>BOT2 2000 P</b>	1750	4500	1580	250	120	2,5-3,5	15-28	1400	2270	880	1180	2000

P = Pesante - Heavy duty



# BENNE BVT 1

## I - Benna bivalve a cilindro verticale per carico e scavi leggeri

GB - Clamshell bucket with vertical cylinder for loading and light digging

D - Zweischalengreifer mit senkrechtem Zylinder für leichte Ausgrabungen und Last

F - Benne preneuse à vérin vertical pour travaux de chargement et de creusage léger

E - Cuchara bivalva con cilindro vertical para carga y excavaciones ligeras

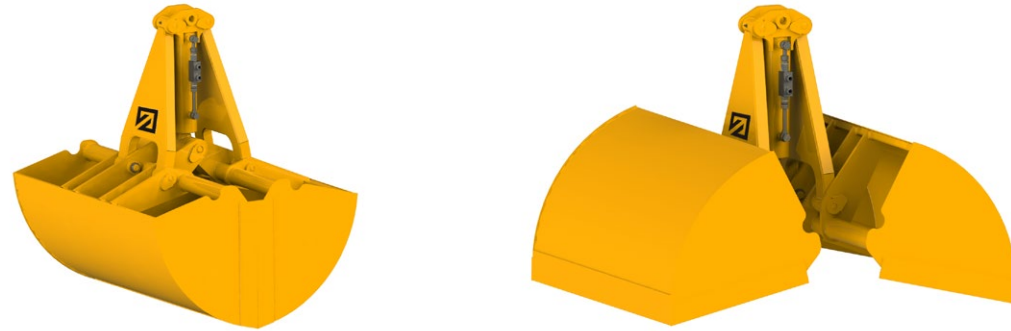

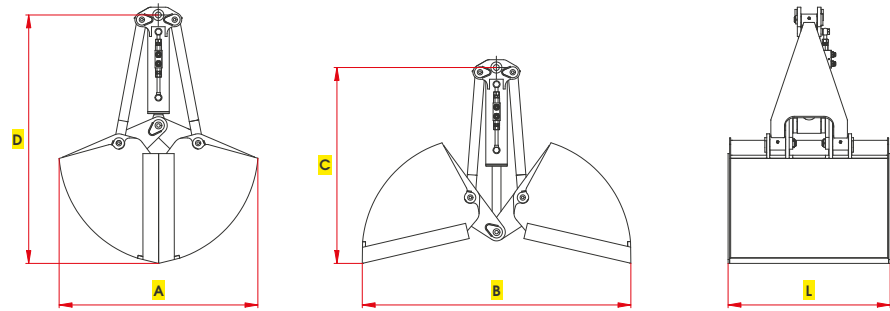

### DISEGNO TECNICO / TECHNICAL DRAWING



 Portata gru a braccio sfilato / Lifting capacity at the end of boom

 Peso escavatore / Excavator weight

Modello Type	Capacità Capacity Lt	Portata Load kg	Peso Weight kg	Pressione Pressure Max bar	Portata olio Oil flow Lt/min	 Ton.	 Ton.	A mm	B mm	C mm	D mm	L mm
<b>BVT 35/1</b>	35	150	65	200	15	0,1-0,3	0,8-1,0	590	730	660	770	300
<b>BVT 55/1</b>	55	250	75	200	15	0,2-0,4	0,8-1,2	590	730	660	770	500
<b>BVT 100/1</b>	100	500	130	200	30	0,4-0,8	1,2-2,0	850	1100	950	1165	430
<b>BVT 155/1</b>	150	500	152	200	30	0,5-0,9	1,5-2,5	850	1100	950	1165	630
<b>BVT 200/1</b>	200	1000	240	200	60	0,8-2,0	2,0-3,5	1020	1370	1010	1280	630
<b>BVT 300/1</b>	300	1000	260	200	60	0,8-2,2	3,0-4,5	1020	1370	1010	1280	830
<b>BVT 400/1</b>	400	1000	280	200	60	0,8-2,4	3,5-7,0	1020	1370	1010	1280	1030
<b>BVT 500/1</b>	500	1000	300	200	60	1,0-2,8	4,0-8,0	1020	1370	1010	1280	1230

# BENNE BVT B

## I - Benna bivalve a cilindro verticale per barbabietole

GB - Clamshell bucket with vertical cylinder for beets

D - Zweischalengreifer mit senkrechtem Zylinder für Rüben

F - Benne preneuse à vérin vertical pour betteraves

E - Cuchara bivalva con cilindro vertical para remolachas

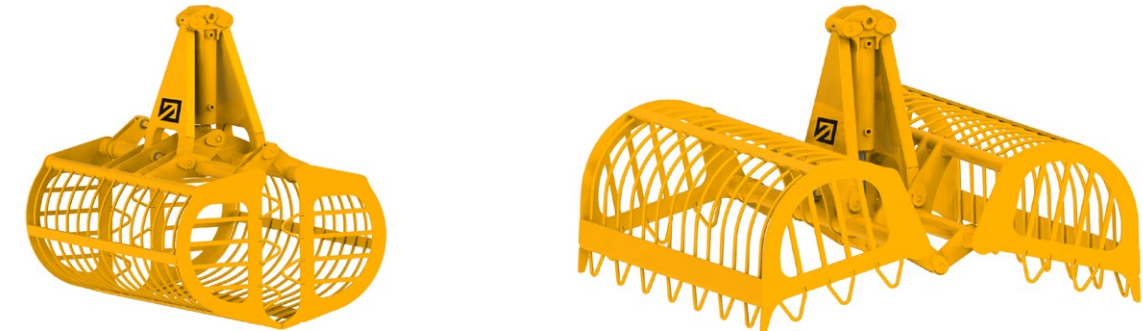

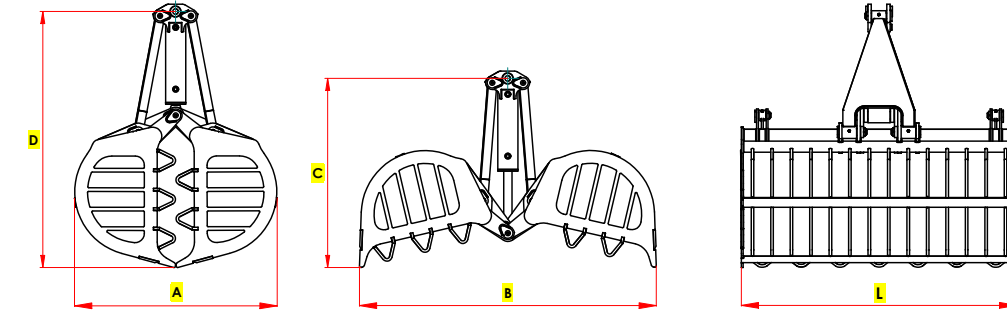

### DISEGNO TECNICO / TECHNICAL DRAWING



 Portata gru a braccio sfilato / Lifting capacity at the end of boom

 Peso escavatore / Excavator weight

Modello Type	Capacità Capacity Lt	Portata Load kg	Peso Weight kg	Pressione Pressure Max bar	Portata olio Oil flow Lt/min	 Ton.	 Ton.	A mm	B mm	C mm	D mm	L mm
<b>BVTB 950/1</b>	515	1000	270	250	60	0,8-1,5	4,0-8,0	1100	1610	1040	1400	950
<b>BVTB 1150/1</b>	630	1000	290	250	60	0,8-1,5	4,0-8,0	1100	1610	1040	1400	1150
<b>BVTB 1350/1</b>	740	1000	310	250	60	1,0-1,8	6,0-10	1100	1610	1040	1400	1350
<b>BVTB 1500/1</b>	830	1000	336	250	60	1,0-1,8	6,0-10	1100	1610	1040	1400	1500

# BENNE BVT 2

## I - Benna bivalente con due cilindri verticali per scavo\*

GB - Clamshell bucket with two vertical cylinders for digging\*

D - Zweischalengreifer mit zwei senkrechten Zylindern für Baugruben\*

F - Benne preneuse avec deux vérins verticaux pour travaux de creusement et de terrassement\*

E - Cuchara bivalva con dos cilindros verticales para excavaciones\*

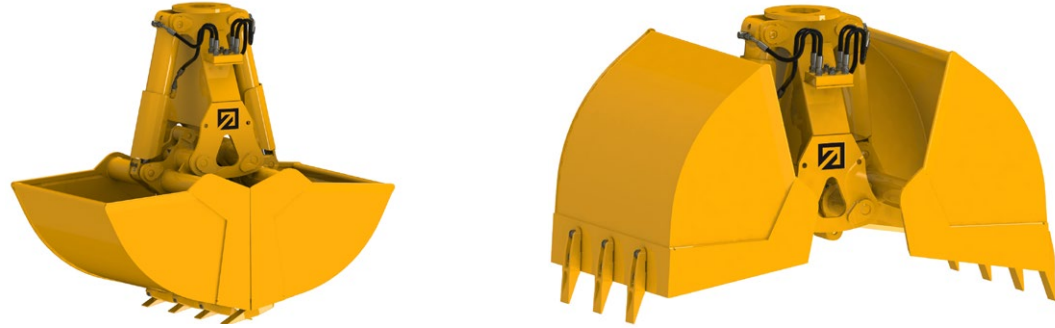

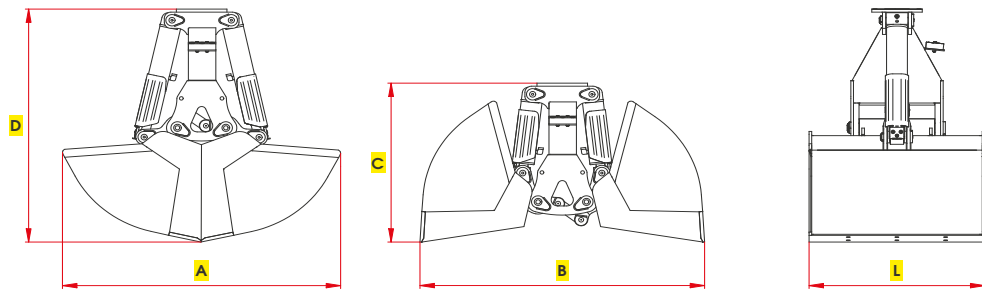

## DISEGNO TECNICO / TECHNICAL DRAWING



Portata gru a braccio sfilato / Lifting capacity at the end of boom



Peso escavatore / Excavator weight

Modello Type	Capacità Capacity Lt	Portata Load kg	Peso Weight kg	Pressione Pressure Max bar	Portata olio Oil flow Lt/min	 Ton.	 Ton.	A mm	B mm	C mm	D mm	L mm
<b>BVT 250/2 L</b>	220	1000	175	250	50	0,5-0,9	1,5-2,5	1200	1150	700	976	500
<b>BVT 350/2 L</b>	260	1000	185	250	50	0,8-2,0	2,0-3,5	1200	1150	700	976	600
<b>BVT 255/2</b>	250	1500	260	250	70	0,8-2,0	3,0-4,5	1300	1280	800	1145	500
<b>BVT 355/2</b>	300	1500	280	250	70	1,2-2,2	5,0-10	1300	1280	800	1145	600
<b>BVT 500/2</b>	410	1500	313	250	70	1,2-2,4	6,0-12	1300	1280	800	1145	800
<b>BVT 600/2</b>	530	1500	346	250	70	1,5-2,8	6,0-12	1300	1280	800	1145	1000
<b>BVT 220/2 P</b>	50	1500	210	250	70	1,5-2,8	7,0-14	910	905	750	960	270
<b>BVT 270/2 P</b>	140	2000	270	250	70	1,5-2,8	7,0-14	1260	1350	860	1190	270
<b>BVT 510/2 P</b>	240	2000	315	250	70	1,5-3,0	7,0-16	1260	1350	860	1190	510

L = Leggera / Light

P = Scassetamento binari / Stripping of rails

\*Espulsore a richiesta / Ejector by request / Auswerfer auf Wunsch / Racleur sur demande / Expulsor a demanda.

The hydraulic grab is a gripping equipment with two shells with synchronized movements actioned by one or more hydraulic cylinders. The hydraulic hook instead consists of a hook and only one hydraulic piston. Body of these hydraulic equipment are made of S355. Parts subjected to traction are made with a high yield strength material such as shells of hydraulic log grabs mod. POTB M or hydraulic grab's hook model PGT.

La pinza idraulica è un'attrezzatura di presa costituita da 2 valve a movimento sincronizzato, azionate da un o più cilindri oleodinamici. Il gancio idraulico invece è composto da un gancio e un solo pistone idraulico. Il corpo di queste attrezzature idrauliche è costruito in S355. Le parti più sottoposte a trazione, sono in materiale che ha un' alta resistenza allo snervamento, come ad esempio le valve delle pinze idrauliche per legna mod. POTB M oppure il gancio della pinza idraulica mod. PGT

# PINZE

GRABS





# PINZE POTB LL

## I - Pinza tronchi a cilindro orizzontale con lama - Serie leggera

GB - Log grab with horizontal cylinder with blade - Light version

D - Holzgreifer mit liegendem Zylinder mit Klinge - Leichte Ausführung

F - Pince à bois à vérin horizontal avec lame - Série légère

E - Pinza para manipulación de troncos con cilindro horizontal con lámina - Serie ligera



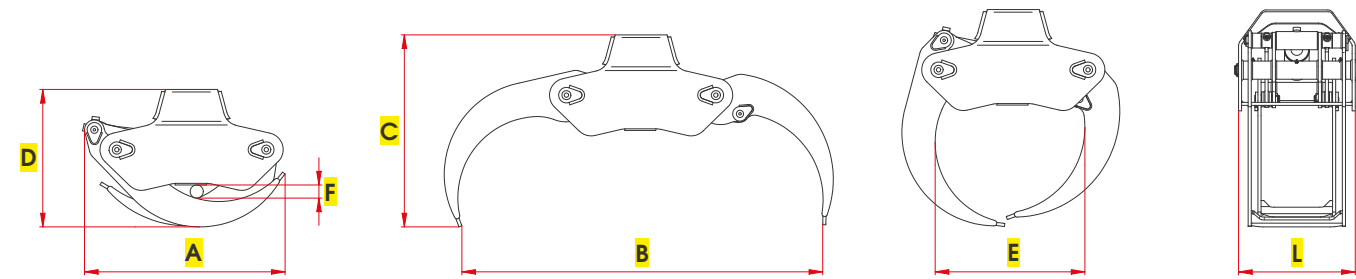

### DISEGNO TECNICO / TECHNICAL DRAWING



 Portata gru a braccio sfilato / Lifting capacity at the end of boom

 Peso escavatore / Excavator weight

Modello Type	Capacità Capacity M <sup>2</sup>	Portata Load kg	Peso Weight kg	Pressione Pressure Max bar	Portata olio Oil flow Lt/min	 Ton.	 Ton.	A mm	B mm	C mm	D mm	E mm	F mm	L mm
POTB 85 LL	0,08	500	33	180	10	0,1-0,3	1,0-1,5	480	820	470	330	350	40	200
POTB 105 LL	0,15	800	55	180	25	0,2-0,5	1,5-2,0	590	1080	570	410	450	45	250
POTB 255 LL	0,20	1500	105	180	30	0,3-0,7	2,0-3,0	670	1250	660	470	510	50	350
POTB 355 LL	0,30	2500	160	180	40	0,5-1,0	3,0-5,0	760	1470	700	530	580	60	450
POTB 455 LL	0,40	3000	240	180	50	0,8-1,6	5,0-8,0	910	1630	880	620	690	70	550

# PINZE POTB L

## I - Pinza tronchi a cilindro orizzontale senza lama - Serie leggera

GB - Log grab with horizontal cylinder without blade - Light version

D - Holzgreifer mit liegendem Zylinder ohne Klinge - Leichte Ausführung

F - Pince à bois à vérin horizontal sans lame - Série légère

E - Pinza para manipulación de troncos con cilindro horizontal sin lámina - Serie ligera



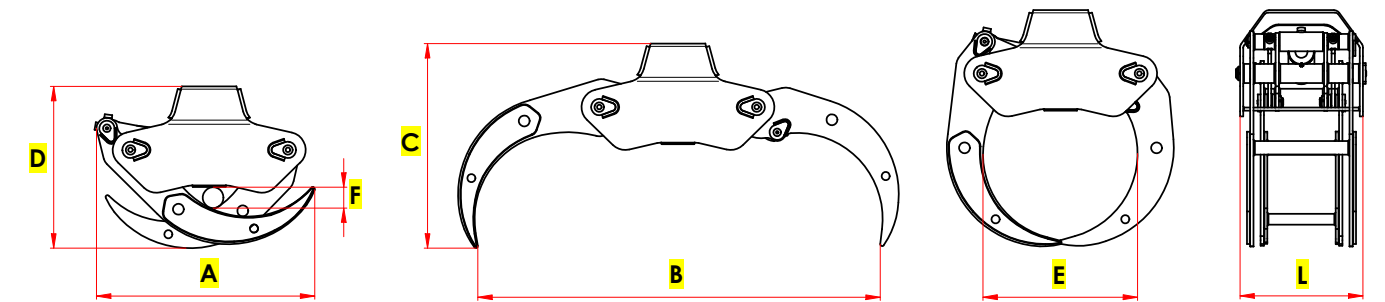

### DISEGNO TECNICO / TECHNICAL DRAWING



 Portata gru a braccio sfilato / Lifting capacity at the end of boom

 Peso escavatore / Excavator weight

Modello Type	Capacità Capacity M <sup>2</sup>	Portata Load kg	Peso Weight kg	Pressione Pressure Max bar	Portata olio Oil flow Lt/min	 Ton.	 Ton.	A mm	B mm	C mm	D mm	E mm	F mm	L mm
POTB 80 L	0,08	500	39	180	10	0,1-0,3	1,0-1,5	480	790	520	375	330	50	200
POTB 100 L	0,15	800	65	180	25	0,2-0,5	1,5-2,0	680	1000	680	450	435	55	250
POTB 250 L	0,20	1500	115	180	30	0,3-0,7	2,0-3,0	720	1300	660	510	510	60	350
POTB 350 L	0,30	2500	170	180	40	0,5-1,0	3,0-5,0	800	1470	750	570	575	67	450
POTB 450 L	0,40	3000	260	180	50	0,8-1,6	5,0-8,0	945	1740	880	690	690	95	550

# KIT DENTI PER POTB L

## I - Kit denti amovibili

- GB - Kit removable teeth
- D - Kit abnehmbaren Zähnen
- F - Kit dents amovibles
- E - Kit dientes amovibles

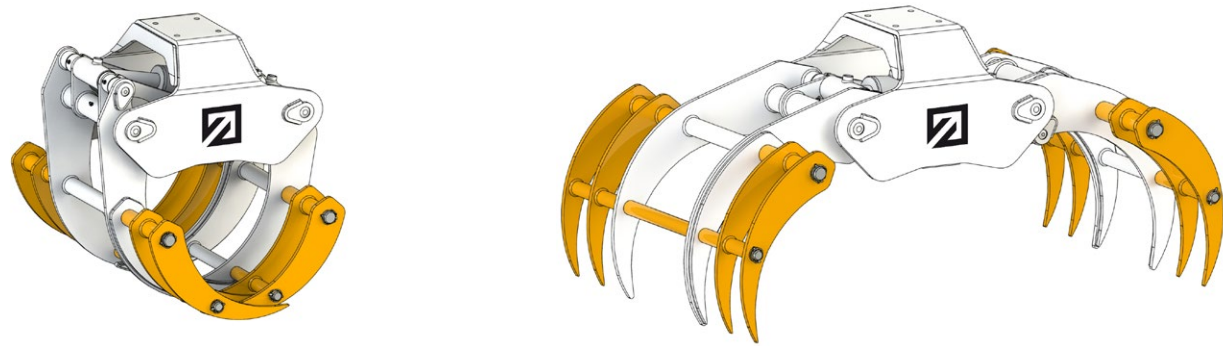

### DISEGNO TECNICO / TECHNICAL DRAWING

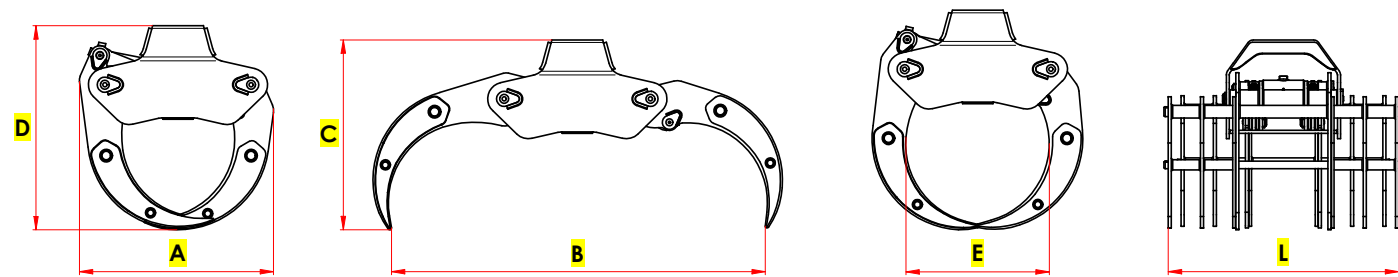

Portata gru a braccio sfilato / Lifting capacity at the end of boom



Peso escavatore / Excavator weight

Modello Type	Capacità Capacity	Portata Load	Peso Weight	Pressione Pressure	Portata olio Oil flow			A	B	C	D	E	F	L
	M <sup>2</sup>	kg	kg	Max bar	Lt/min	Ton.	Ton.	mm	mm	mm	mm	mm	mm	mm
<b>KD-POTB 80 L</b>	0,08	500	59	180	10	0,1-0,3	1,0-1,5	465	790	520	500	330	206	448
<b>KD-POTB 100 L</b>	0,15	800	105	180	25	0,2-0,5	1,5-2,0	570	1000	680	665	435	310	650
<b>KD-POTB 250 L</b>	0,20	1500	170	180	30	0,3-0,7	2,0-3,0	680	1300	660	725	510	330	750
<b>KD-POTB 350 L</b>	0,30	2500	250	180	40	0,5-1,0	3,0-5,0	765	1470	750	800	575	360	910
<b>KD-POTB 450 L</b>	0,40	3000	370	180	50	0,8-1,6	5,0-8,0	910	1740	880	945	690	430	1010

# KIT BENNA PER POTB L

## I - Kit pareti benna amovibili

- GB - Kit removable side-walls
- D - Kit abnehmbaren Seitenschalen
- F - Kit parois amovibles
- E - Kit paredes laterales amovibles

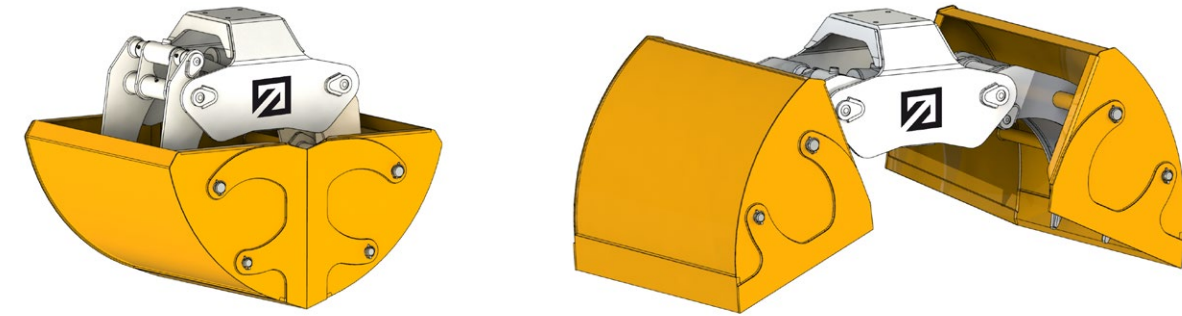

### DISEGNO TECNICO / TECHNICAL DRAWING

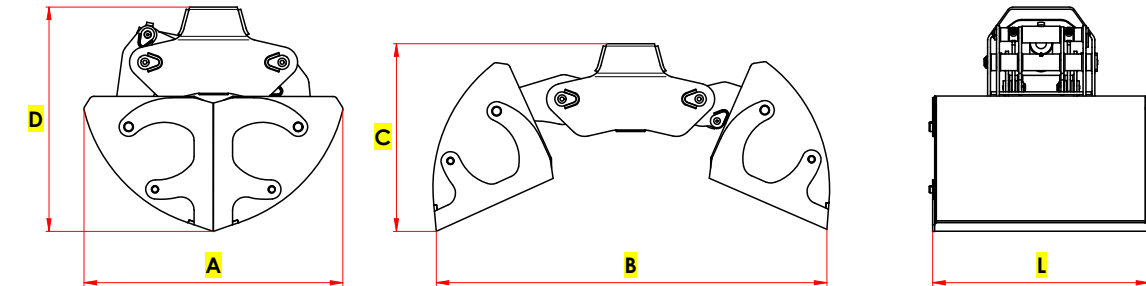

Portata gru a braccio sfilato / Lifting capacity at the end of boom



Peso escavatore / Excavator weight

Modello Type	Capacità Capacity	Portata Load	Peso Weight	Pressione Pressure	Portata olio Oil flow			A	B	C	D	L
	Lt	kg	kg	Max bar	Lt/min	Ton.	Ton.	mm	mm	mm	mm	mm
<b>KB-POTB 80 L</b>	70	500	81	180	10	0,1-0,3	1,0-1,5	660	854	545	585	448
<b>KB-POTB 100 L</b>	160	800	143	180	25	0,2-0,5	1,5-2,0	835	1000	700	740	650
<b>KB-POTB 250 L</b>	240	1500	215	180	30	0,3-0,7	2,0-3,0	960	1450	690	830	750
<b>KB-POTB 350 L</b>	370	2500	310	180	40	0,5-1,0	3,0-5,0	1080	1640	785	940	910
<b>KB-POTB 450 L</b>	550	3000	440	180	50	0,8-1,6	5,0-8,0	1240	1920	910	1100	1010

# PINZE POTB M

## I - Pinza tronchi a cilindro orizzontale con lama - Serie pesante

GB - Log grab with horizontal cylinder with blade - Heavy version

D - Holzgreifer mit liegendem Zylinder mit Klinge - Schwere Ausführung

F - Pince à bois à vérin horizontal avec lame - Série industriel

E - Pinza para manipulación de troncos con cilindro horizontal con lámina - Serie pesada



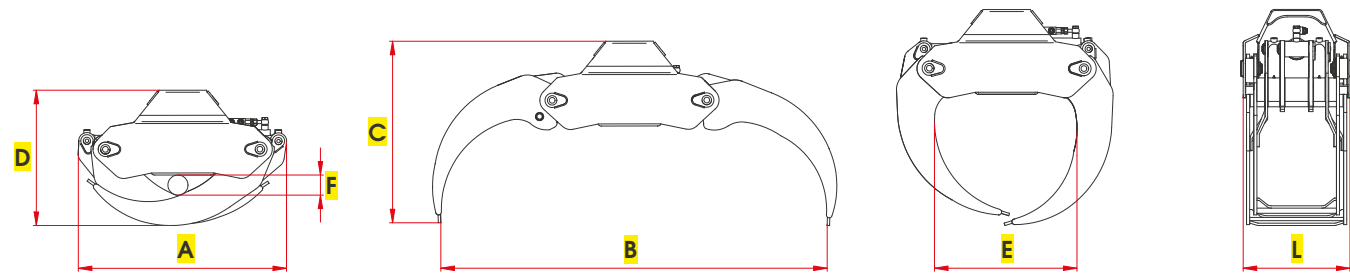

### DISEGNO TECNICO / TECHNICAL DRAWING



 Portata gru a braccio sfilato / Lifting capacity at the end of boom

 Peso escavatore / Excavator weight

Modello Type	Capacità Capacity	Portata Load	Peso Weight	Pressione Pressure	Portata olio Oil flow			A	B	C	D	E	F	L
	M <sup>2</sup>	kg	kg	Max bar	Lt/min	Ton.	Ton.	mm	mm	mm	mm	mm	mm	mm
POTB 100 M	0,15	1200	87	200	35	0,2-0,6	2,0-3,5	640	1180	570	430	465	70	340
POTB 200 M	0,20	2000	110	200	40	0,4-0,8	3,5-5,0	740	1400	630	470	540	80	360
POTB 300 M	0,30	3000	210	200	50	0,8-1,6	5,0-9,0	865	1630	750	570	600	90	440
POTB 400 M	0,40	4000	300	200	60	1,5-2,8	8,0-13	1000	1880	870	650	690	95	530
POTB 530 M	0,53	5000	470	200	80	1,5-3,5	12-18	1150	2170	1000	780	850	120	610

# PINZE POTB H

## I - Pinza tronchi a cilindro orizzontale senza lama - Serie pesante

GB - Log grab with horizontal cylinder without blade - Heavy version

D - Holzgreifer mit liegendem Zylinder ohne Klinge - Schwere Ausführung

F - Pince à bois à vérin horizontal sans lame - Série industriel

E - Pinza para manipulación de troncos con cilindro horizontal sin lámina - Serie pesada



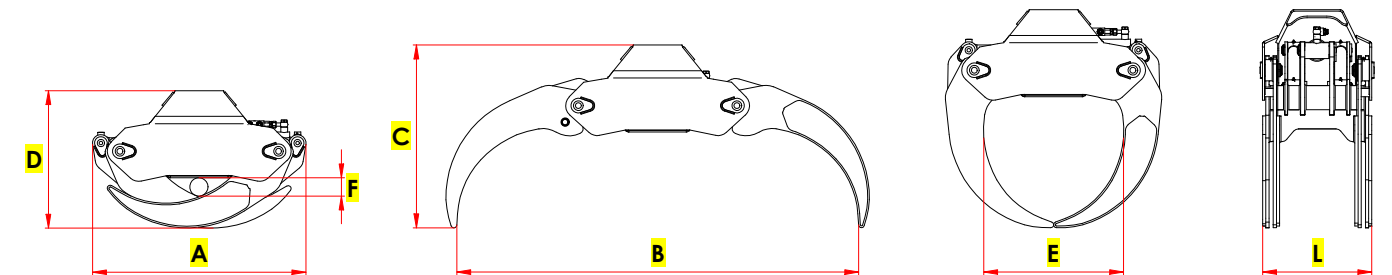

### DISEGNO TECNICO / TECHNICAL DRAWING



 Portata gru a braccio sfilato / Lifting capacity at the end of boom

 Peso escavatore / Excavator weight

Modello Type	Capacità Capacity	Portata Load	Peso Weight	Pressione Pressure	Portata olio Oil flow			A	B	C	D	E	F	L
	M <sup>2</sup>	kg	kg	Max bar	Lt/min	Ton.	Ton.	mm	mm	mm	mm	mm	mm	mm
POTB 104 H	0,15	1200	93	200	35	0,2-0,6	2,0-3,5	640	1190	560	430	450	68	340
POTB 204 H	0,20	2000	122	200	40	0,4-0,8	3,5-5,0	740	1300	630	450	500	70	360
POTB 304 H	0,30	3000	230	200	50	0,8-1,6	5,0-9,0	865	1610	720	550	560	80	440
POTB 404 H	0,40	4000	330	200	60	1,5-2,8	8,0-13	1000	1900	850	650	690	90	530



# PINZE POTB 2

## I - Pinza tronchi a due cilindri orizzontali, con lama, per escavatore

GB - Log grab with two horizontal cylinders, with blade, for excavator

D - Holzgreifer mit zwei liegenden Zylindern, mit Klinge, für Bagger

F - Pince à bois à deux vérins horizontal, avec lame, pour pelle

E - Pinza para troncos con dos cilindros horizontal, con lamina, para excavadora



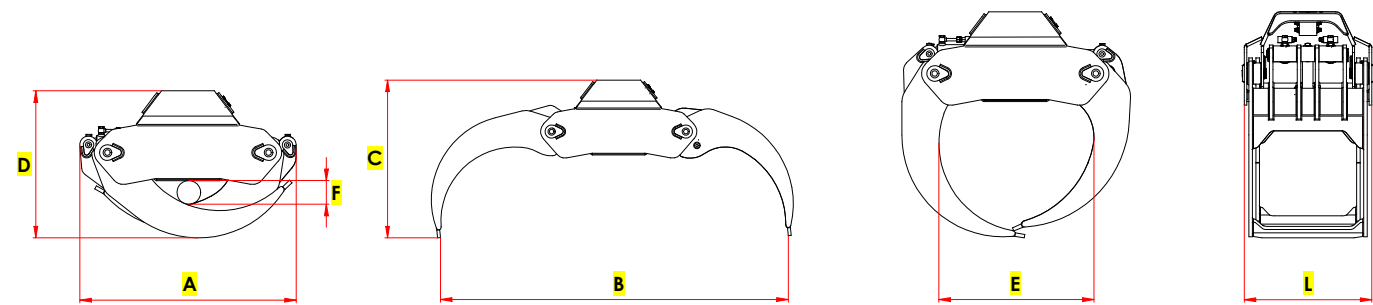

### DISEGNO TECNICO / TECHNICAL DRAWING



 Portata gru a braccio sfilato / Lifting capacity at the end of boom

 Peso escavatore / Excavator weight

Modello Type	Capacità Capacity	Portata Load	Peso Weight	Pressione Pressure	Portata olio Oil flow			A	B	C	D	E	F	L
	M <sup>2</sup>	kg	kg	Max bar	Lt/min	Ton.	Ton.	mm	mm	mm	mm	mm	mm	mm
POTB 650/2	0,65	6500	670	300	100	-	18-25	1240	2350	1070	840	920	135	750

# PINZE PMT

## I - Pinza per la movimentazione di massi

GB - Grab for rocks handling

D - Greifer für den Umschlag von Felsen und Steinen

F - Pince d'embrochement et de tri

E - Pinza para el manejo de rocas

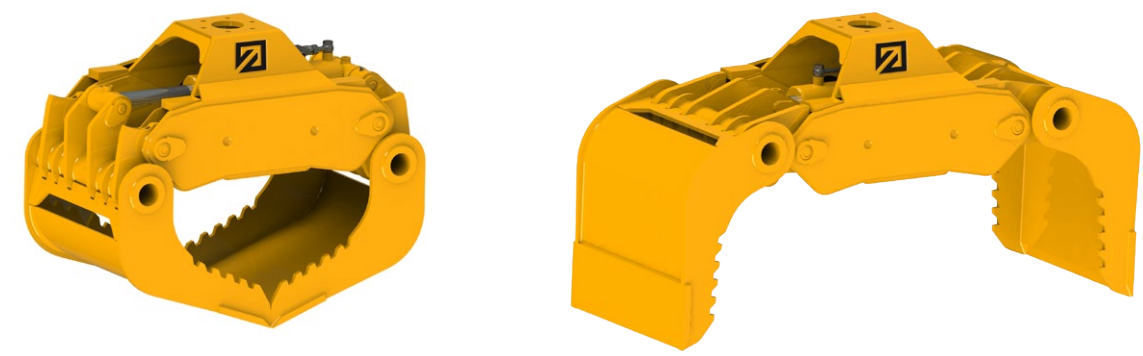

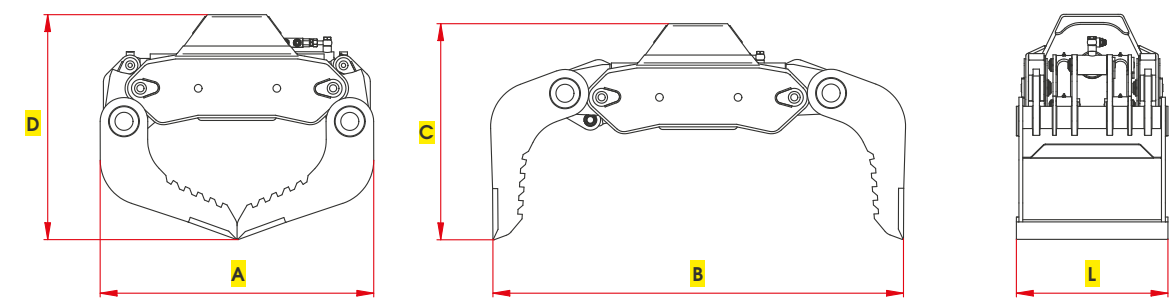

### DISEGNO TECNICO / TECHNICAL DRAWING



 Portata gru a braccio sfilato / Lifting capacity at the end of boom

 Peso escavatore / Excavator weight

Modello Type	Portata Load	Peso Weight	Pressione Pressure	Portata olio Oil flow			A	B	C	D	L
	kg	kg	Max bar	Lt/min	Ton.	Ton.	mm	mm	mm	mm	mm
PMT 110	1100	127	200	35	0,3-0,6	2,0-4,0	670	1015	530	560	390
PMT 210	1600	180	200	40	0,4-0,8	3,5-5,0	770	1160	580	615	410
PMT 310	2000	300	200	50	0,8-1,6	5,0-9,0	900	1370	710	750	490
PMT 410	3500	400	200	60	1,5-2,8	8,0-13	1060	1610	830	880	590
PMT 510	4500	600	200	80	1,5-3,5	12-18	1200	1830	950	1000	650

# PINZE PMC

## I - Attrezzatura per la manutenzione ferroviaria: Pinza compattatrice di massiciata

GB - Hydraulic equipment for railway maintenance: Ballast compacting grab

D - Hydraulische Ausrüstung für Eisenbahnstandhaltung: Zange für Gleisbettungsverdichtung

F - Equipement hydraulique pour l'entretien des chemins de fer: Pince compacteur de ballast

E - Equipo para el mantenimiento de líneas ferroviarias: Pinza de compactación de balasto



### DISEGNO TECNICO / TECHNICAL DRAWING

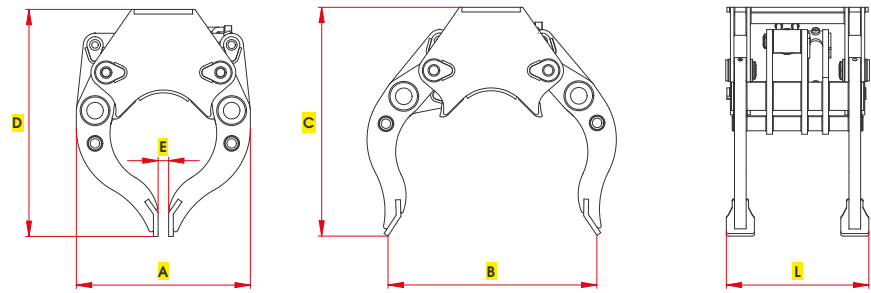

Portata gru a braccio sfilato / Lifting capacity at the end of boom



Peso escavatore / Excavator weight

Modello Type	Peso Weight kg	Pressione Pressure Max bar	Portata olio Oil flow Lt/min	Ton.	Ton.	A mm	B mm	C mm	D mm	E mm	L mm
PMC 520	470	250	50	-	13-25	745	890	970	970	45	610
PMC 520 LX	490	250	50	-	13-25	745	890	1100	1100	45	610

# PINZE PTT 2

## I - Attrezzatura per la manutenzione ferroviaria: Pinza per la presa di traversine

GB - Hydraulic equipment for railway maintenance: Sleepers grab

D - Hydraulische Ausrüstung für Eisenbahnstandhaltung: Schwellenzange

F - Equipement hydraulique pour l'entretien des chemins de fer: Pince pour la reprise des traverses

E - Equipo para el mantenimiento de líneas ferroviarias: Pinza de carga serie de traviesas

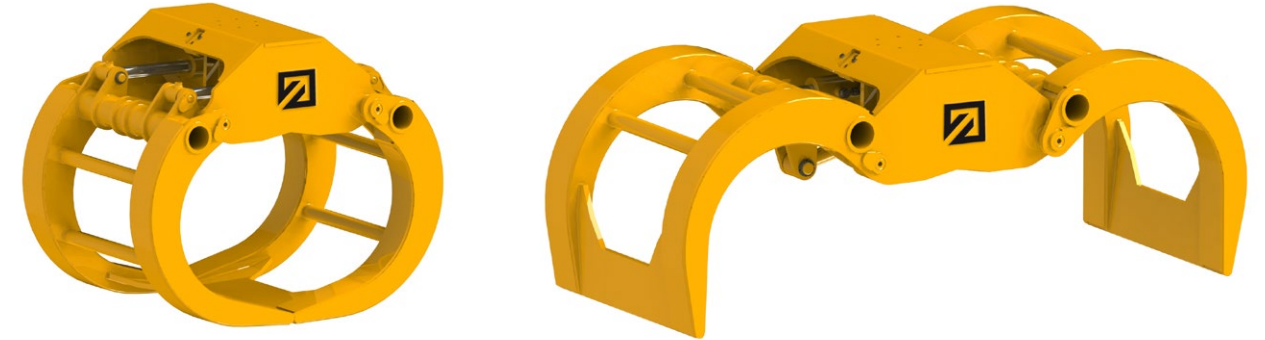

### DISEGNO TECNICO / TECHNICAL DRAWING

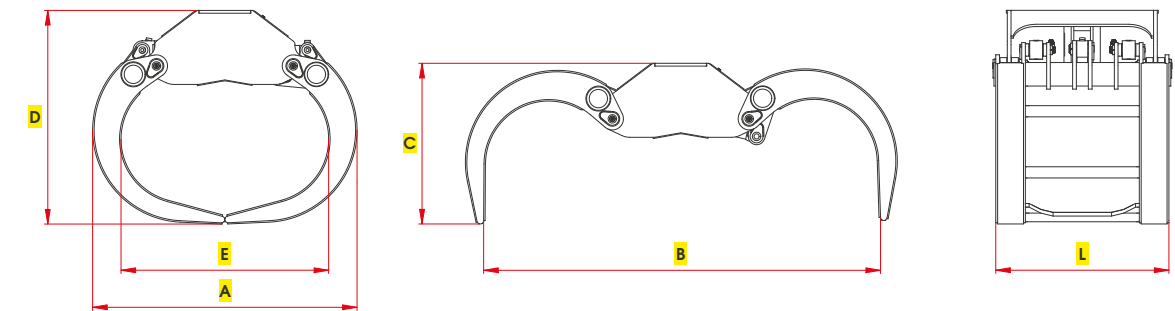

Portata gru a braccio sfilato / Lifting capacity at the end of boom



Peso escavatore / Excavator weight

Modello Type	Capacità Capacity M <sup>2</sup>	Portata Load kg	Peso Weight kg	Pressione Pressure Max bar	Portata olio Oil flow Lt/min	Ton.	Ton.	A mm	B mm	C mm	D mm	E mm	L mm
PTT 2 100 L	0,70	3000	650	250	100	1,5-2,4	10-17	1420	2164	865	1153	1130	930
PTT 2 100 P	0,70	4000	830	250	100	2,5-3,5	15-24	1420	2164	865	1153	1130	940

# PINZE PRT

## I - Attrezzatura per la manutenzione ferroviaria: Pinza per la movimentazione di rotaie

GB - Hydraulic equipment for railway maintenance: Rails lifting grab

D - Hydraulische Ausrüstung für Eisenbahnstandhaltung: Schienenzange

F - Equipement hydraulique pour l'entretien des chemins de fer: Pince pour le levage de rails

E - Equipo para el mantenimiento de líneas ferroviarias: Pinza para el manejo de carriles

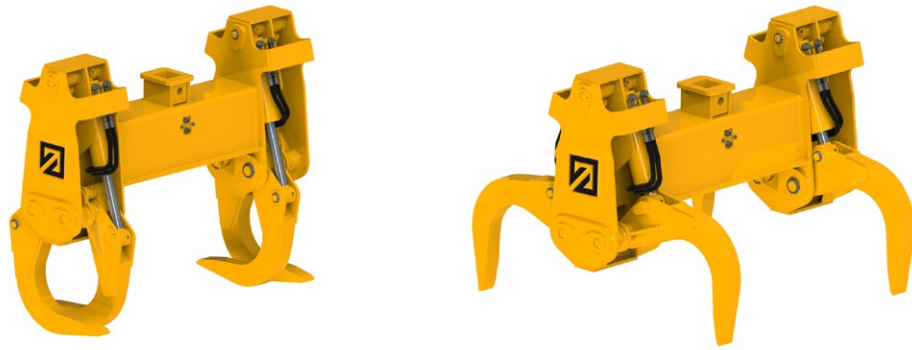

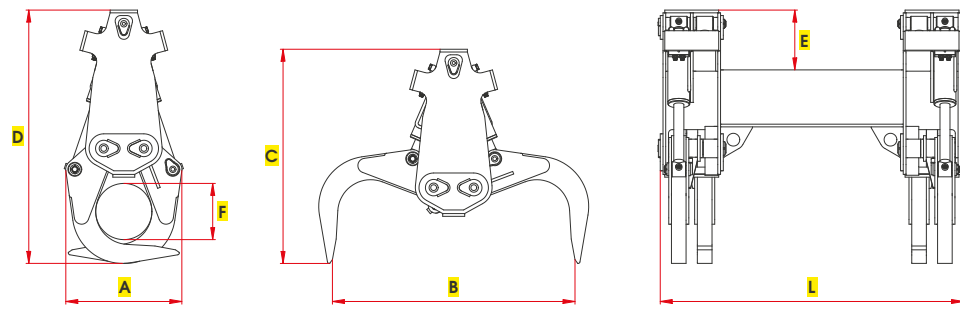

### DISEGNO TECNICO / TECHNICAL DRAWING



 Portata gru a braccio sfilato / Lifting capacity at the end of boom

 Peso escavatore / Excavator weight

Modello Type	Portata Load kg	Peso Weight kg	Pressione Pressure Max bar	Portata olio Oil flow Lt/min	 Ton.	 Ton.	A mm	B mm	C mm	D mm	E mm	F mm	L mm
<b>PRT 960</b>	4500	560	250	100	1,5-2,2	13-20	540	1120	980	1180	280	260	1200
<b>PRT 990</b>	7000	900	250	150	2,0-3,5	20-35	640	1320	1150	1400	330	300	1660

# PINZE PTL

## I - Pinza per la movimentazione di pacchi laterizi

GB - Brick stack grapple

D - Steinstapelzange

F - Pince à parpaings

E - Pinza para pilas de ladrillos



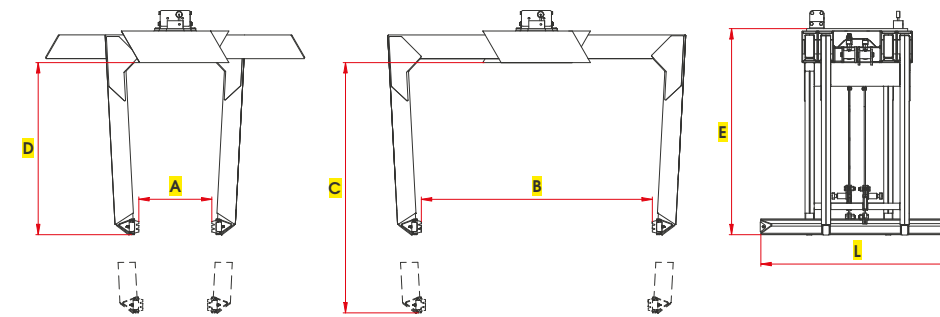

### DISEGNO TECNICO / TECHNICAL DRAWING



 Portata gru a braccio sfilato / Lifting capacity at the end of boom

 Peso escavatore / Excavator weight

Modello Type	Portata Load kg	Peso Weight kg	Pressione Pressure Max bar	Portata olio Oil flow Lt/min	 Ton.	 Ton.	A mm	B mm	C mm	D mm	E mm	L mm
<b>PTL R 2000</b>	2000*	350	200	60	1,8-2,5	5,0-12	450	1400	1350 1500 Kg	970 2000 Kg	1180	1220
<b>PTL RA 2000</b>	2000*	370	200	60	1,8-2,5	5,0-12	450	1400	1700 1400 Kg	1100 2000 Kg	1300	1220
<b>PTL F 2000</b>	2000	330	200	60	1,8-2,5	5,0-12	450	1400	-	1200 2000 Kg	1400	1220
<b>PTL R 3000</b>	3000*	500	250	60	2,2-3,5	8,0-15	450	1400	1350 2500 Kg	1100 3000 Kg	1350	1220
<b>PTL F 3000</b>	3000	430	250	60	2,2-3,5	8,0-15	450	1400	-	1200 3000 Kg	1450	1220

\*Portata variabile vedi colonna C e D / Look column C and D for changeable weight load



# PINZE PFL

## I - Pinza per la movimentazione di pacchi vari

GB - Grab for handling various parcels

D - Zange für Verschiedene Pakete zum Bewegen

F - Pinçe pour la manipulation de parcelles différentes

E - Pinza para el manejo de paquetes varios

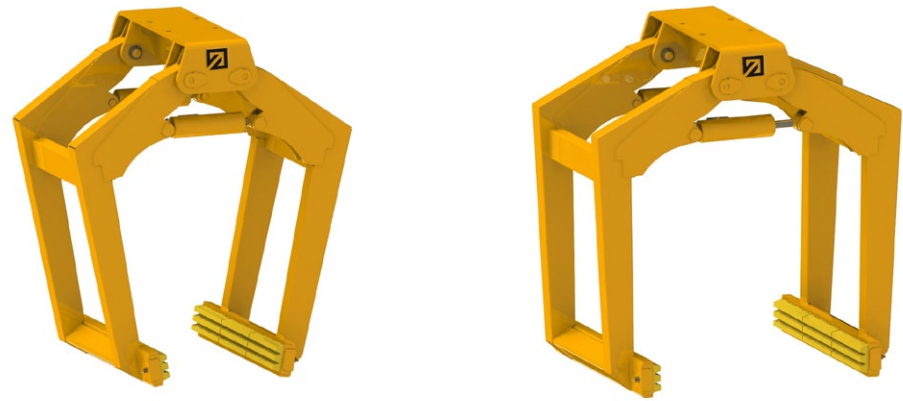

### DISEGNO TECNICO / TECHNICAL DRAWING

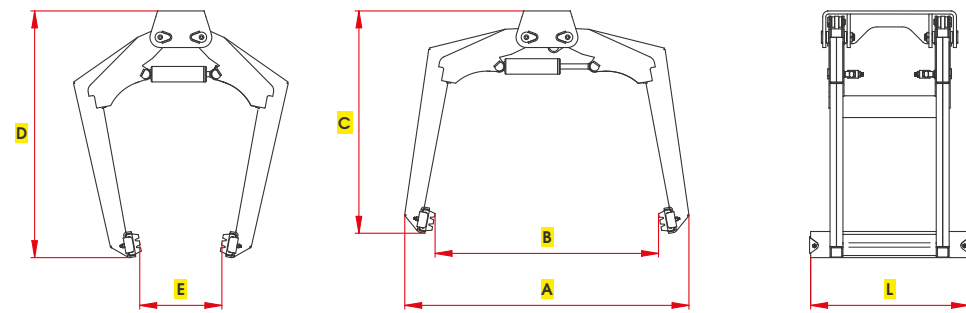

Portata gru a braccio sfilato / Lifting capacity at the end of boom



Peso escavatore / Excavator weight

Modello Type	Portata Load kg	Peso Weight kg	Pressione Pressure Max bar	Portata olio Oil flow Lt/min	Ton.	Ton.	A mm	B mm	C mm	D mm	E mm	L mm
<b>PFL 150</b>	500	117	200	20	0,3-1,5	2,5-4,5	1090	850	860	955	300	615
<b>PFL 180</b>	2000	290	200	60	1,8-2,5	5-12	1735	1480	1430	1575	220	1220

# PINZE PRCT

## I - Gancio idraulico per campane vetro

GB - Hydraulic hook for handling glass bell-shaped containers

D - Hydraulischer Altglascontainerhaken

F - Crochet hydraulique pour conteneurs à verre

E - Gancho hidráulico para contenedores de vidrio



### DISEGNO TECNICO / TECHNICAL DRAWING

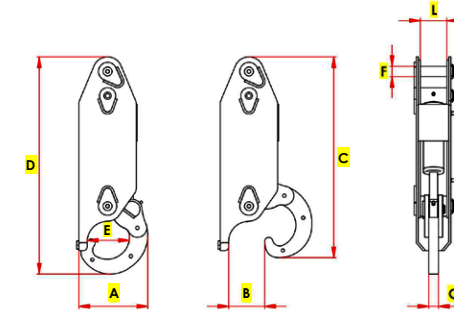

Portata gru a braccio sfilato / Lifting capacity at the end of boom



Peso escavatore / Excavator weight

Modello Type	Portata Load kg	Peso Weight kg	Pressione Pressure Max bar	Portata olio Oil flow Lt/min	Ton.	Ton.	A mm	B mm	C mm	D mm	E mm	F mm	G mm	L mm
<b>PRCT 100</b>	1000	11	200	5	0,5-1,3	1,5-3,0	127	83	413	450	86	20	24	57
<b>PRCT 180</b>	1800	15	200	5	1,0-1,8	2,0-5,5	170	89	494	540	115	25	24	65
<b>PRCT 250</b>	2500	23	200	5	1,5-2,5	4,0-8,0	190	130	510	565	123	30	30	72

# PINZE PGT

## I - Gancio idraulico

- GB - Hydraulic hook
- D - Hydraulischer Haken
- F - Crochet hydraulique
- E - Gancho hidráulico

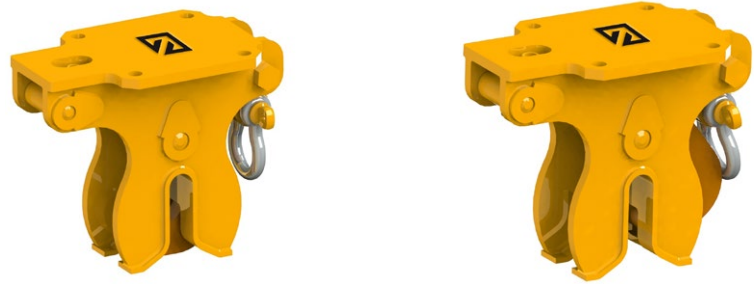

## DISEGNO TECNICO / TECHNICAL DRAWING

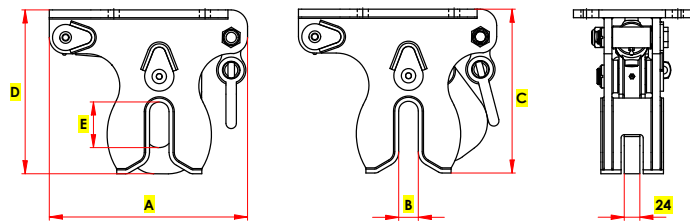

Portata gru a braccio sfilato / Lifting capacity at the end of boom



Peso escavatore / Excavator weight

Modello Type	Portata Load kg	Peso Weight kg	Pressione Pressure Max bar	Portata olio Oil flow Lt/min	Ton.	Ton.	A mm	B mm	C mm	D mm	E mm
PGT 330	3300	20	200	5	1,5-3,5	4,0-9,0	304	30	250	250	70





Forks are gripping equipment with 2 shells with synchronized movement, actioned by an hydraulic cylinder.

These grabs' body is entirely made of S355, they are available with one or two cylinders, either horizontal or vertical and they are used for loading and unloading different materials such as waste, manure, brush wood, straw, wallboards or panels.

La forca è un'attrezzatura di presa costituita da 2 valve a movimento sincronizzato, azionate da un cilindro oleodinamico. Il corpo delle nostre forche è costruito in S355, sono disponibili con uno o due cilindri, questi pistoni idraulici possono essere orizzontali o verticali e le attrezzature vengono usate per carico e scarico di materiali differenti quali rifiuti solidi urbani, per la raccolta di letame, rami secchi, fogliame, fieno, pareti in cartongesso o pannelli in generale.

# FORCHE

MULTIPURPOSE FORKS





# FORCHE FOTB

## I - Forca a cilindro orizzontale per lavori agricoli

GB - Grab with horizontal cylinder for agricultural works

D - Mistgreifer mit liegendem Zylinder für die landwirtschaftliche Arbeit

F - Fourche à vérin horizontal pour les travaux agricoles

E - Horquilla con cilindro horizontal para el trabajo agrícola

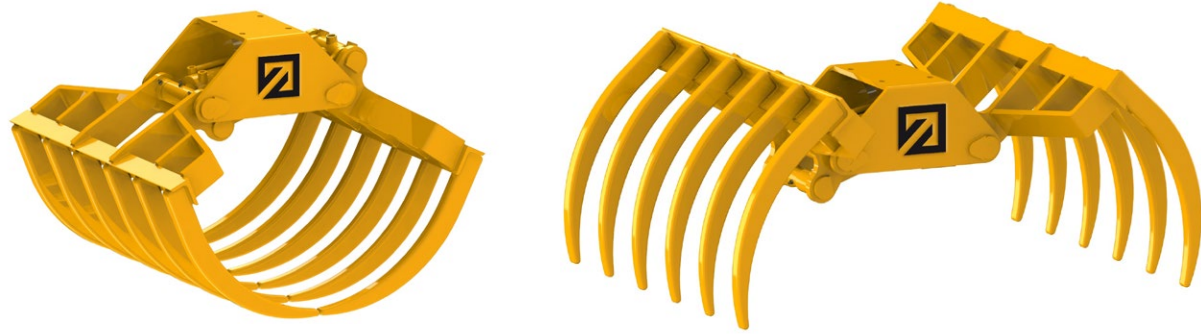

### DISEGNO TECNICO / TECHNICAL DRAWING

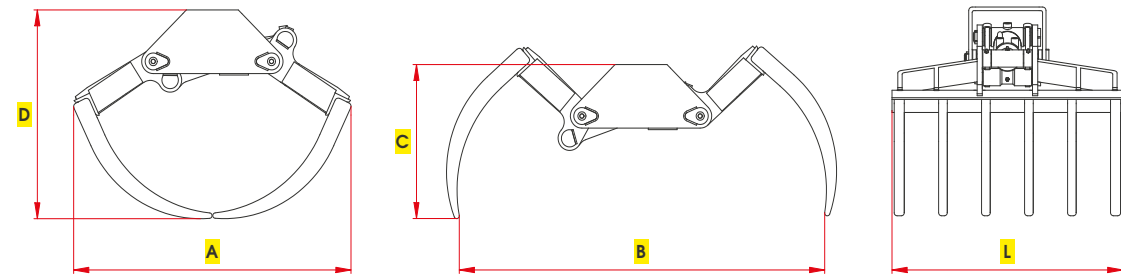

Portata gru a braccio sfilato / Lifting capacity at the end of boom



Peso escavatore / Excavator weight

Modello Type	Denti Teeth nr.	Peso Weight kg	Pressione Pressure Max bar	Portata olio Oil flow Lt/min	Ton.	Ton.	A mm	B mm	C mm	D mm	L mm
<b>FOTB 6</b>	6	110	250	20	0,2-0,4	2,0-3,0	960	1270	510	690	400
<b>FOTB 8</b>	8	130	250	20	0,4-0,6	3,0-4,0	960	1270	510	690	500
<b>FOTB 10</b>	10	145	250	20	0,4-0,9	3,0-7,0	960	1270	510	690	650
<b>FOTB 12</b>	12	165	250	20	0,6-1,0	4,0-8,0	960	1270	510	690	800
<b>FOTB 14</b>	14	185	250	20	0,8-1,5	5,0-9,0	960	1270	510	690	950
<b>FOTB 16</b>	16	205	250	20	1,0-1,8	6,0-10	960	1270	510	690	1100
<b>FOTB L 8</b>	8	90	200	15	0,15-0,3	1,2-1,8	895	1120	465	613	450
<b>FOTB L 10</b>	10	97	200	15	0,2-0,4	1,5-2,2	895	1120	465	613	550
<b>FOTB L 12</b>	12	110	200	15	0,2-0,6	1,8-2,5	895	1120	465	613	700

L = Serie leggera \ Light serie

# FORCHE FVTB

## I - Forca a cilindro verticale per lavori agricoli

GB - Grab with vertical cylinder for agricultural works

D - Mistgreifer mit senkrechtem Zylinder für die landwirtschaftliche Arbeit

F - Fourche à vérin vertical pour les travaux agricoles

E - Horquilla con cilindro vertical para el trabajo agrícola

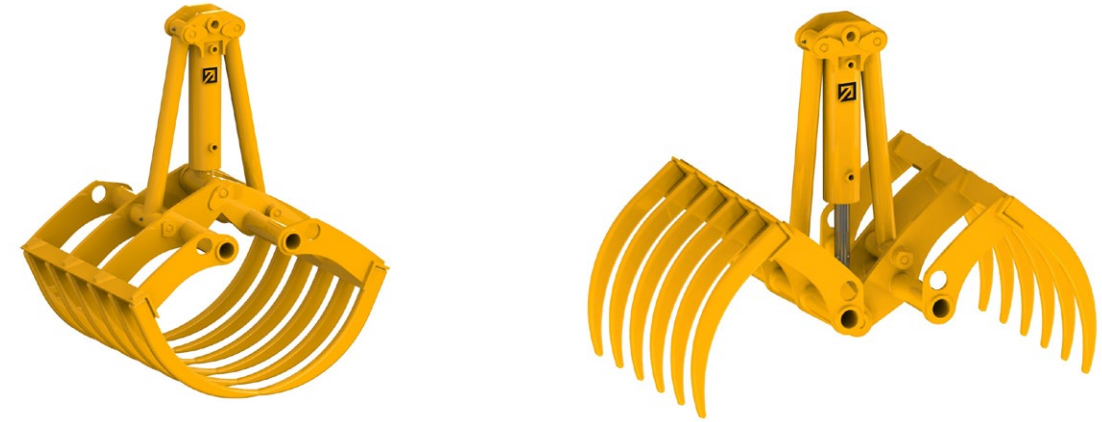

### DISEGNO TECNICO / TECHNICAL DRAWING

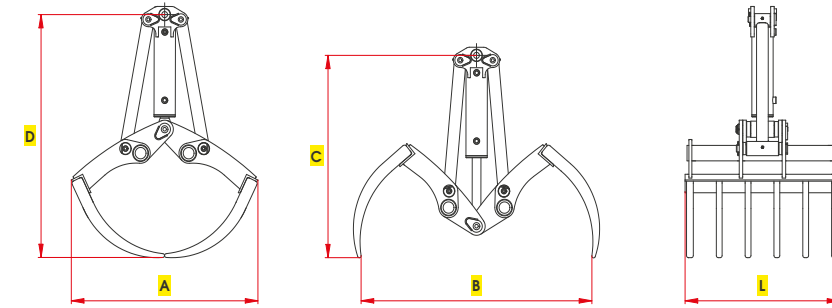

Portata gru a braccio sfilato / Lifting capacity at the end of boom



Peso escavatore / Excavator weight

Modello Type	Denti Teeth nr.	Peso Weight kg	Pressione Pressure Max bar	Portata olio Oil flow Lt/min	Ton.	Ton.	A mm	B mm	C mm	D mm	L mm
<b>FVTB 6</b>	6	140	250	60	0,2-0,4	2,0-3,0	1000	1200	1000	1200	400
<b>FVTB 8</b>	8	155	250	60	0,4-0,6	3,0-4,0	1000	1200	1000	1200	500
<b>FVTB 10</b>	10	170	250	60	0,4-0,9	3,0-7,0	1000	1200	1000	1200	650
<b>FVTB 12</b>	12	185	250	60	0,6-1,0	4,0-8,0	1000	1200	1000	1200	800
<b>FVTB 14</b>	14	200	250	60	0,8-1,5	5,0-9,0	1000	1200	1000	1200	950
<b>FVTB 16</b>	16	215	250	60	1,0-1,8	6,0-10	1000	1200	1000	1200	1100

# FORCHE FOTB 2

## I - Forca a due cilindri orizzontali per lavori agricoli

GB - Grab with two horizontal cylinders for agricultural works

D - Mistgreifer mit zwei liegenden Zylindern für die landwirtschaftliche Arbeit

F - Fourche à deux vérins horizontaux pour les travaux agricoles

E - Horquilla con dos cilindros horizontales para el trabajo agrícola



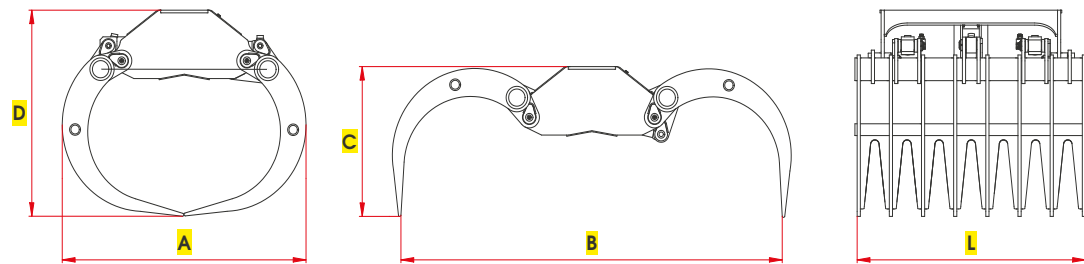

### DISEGNO TECNICO / TECHNICAL DRAWING



 Portata gru a braccio sfilato / Lifting capacity at the end of boom

 Peso escavatore / Excavator weight

Modello Type	Denti Teeth nr.	Peso Weight kg	Pressione Pressure Max bar	Portata olio Oil flow Lt/min	 Ton.	 Ton.	A mm	B mm	C mm	D mm	L mm
FOTB 16/2	16	480	250	50	1,5-2,0	8,0-12	1162	1810	691	845	1100
FOTB 20/2	20	550	250	50	1,8-2,2	10-14	1162	1810	691	845	1400

# FORCHE FVTB 2

## I - Forca a due cilindri verticali per lavori agricoli

GB - Grab with two vertical cylinders for agricultural works

D - Mistgreifer mit zwei senkrechten Zylindern für die landwirtschaftliche Arbeit

F - Fourche à deux vérins verticaux pour les travaux agricoles

E - Horquilla con dos cilindros verticales para el trabajo agrícola

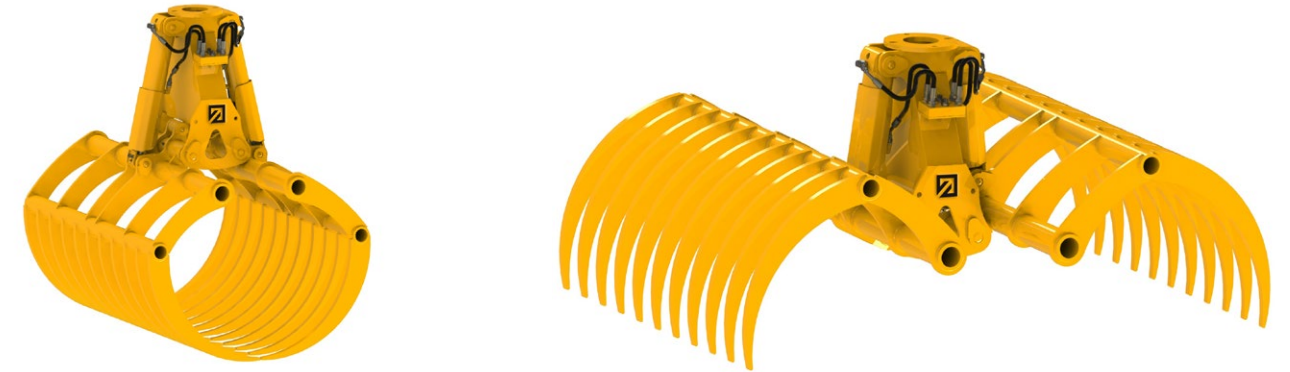

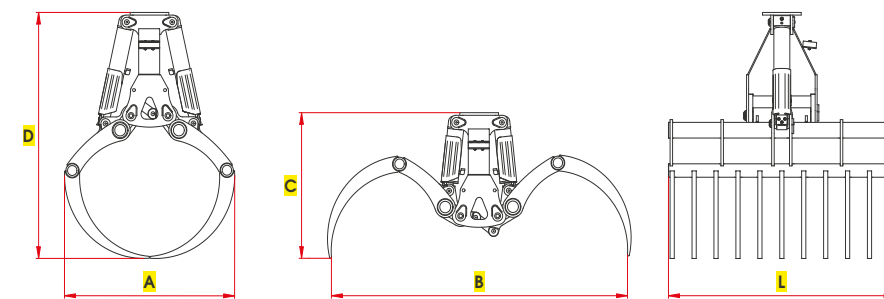

### DISEGNO TECNICO / TECHNICAL DRAWING



 Portata gru a braccio sfilato / Lifting capacity at the end of boom

 Peso escavatore / Excavator weight

Modello Type	Denti Teeth nr.	Peso Weight kg	Pressione Pressure Max bar	Portata olio Oil flow Lt/min	 Ton.	 Ton.	A mm	B mm	C mm	D mm	L mm
FVTB 20/2	20	450	250	70	1,5-2,0	8,0-12	1000	1700	820	1400	1200
FVTB 22/2	22	485	250	70	1,8-2,2	10-14	1000	1700	820	1400	1350
FVTB 24/2	24	520	250	70	1,8-2,4	12-15	1000	1700	820	1400	1500

# FORCHE FOTB S

## I - Forca "multi uso" a denti incrociati per la movimentazione di vari materiali quali letame, fieno, ramaglie, rifiuti

GB - "Multi-purpose" grab with crossed tines for handling different materials such as manure, straw, branches, waste

D - Mehrzweck-Mistgreifer mit gekreuzten Zinken für den Umschlag von verschiedenen Werkstoffen wie Mist, Heu, Zweige, Müll

F - Fourche multifonction avec dents croisés pour le chargement et le déchargement des différents matériaux tels que fumier, foin, brindilles, déchets

E - Horquilla de usos múltiples con dientes cruzados para la carga de materiales diversos como estiércol, heno, ramizas, desechos



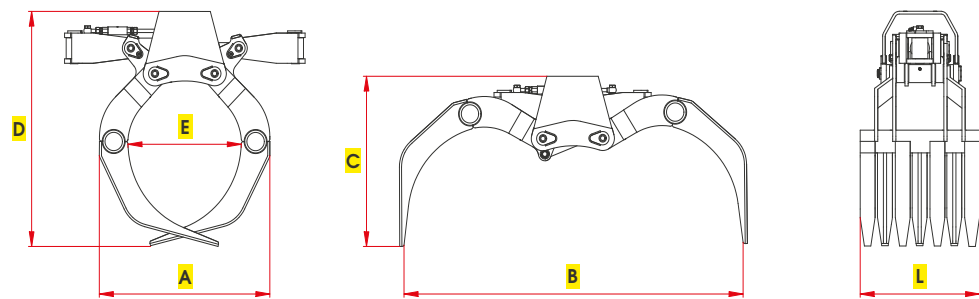

### DISEGNO TECNICO / TECHNICAL DRAWING



 Portata gru a braccio sfilato / Lifting capacity at the end of boom

 Peso escavatore / Excavator weight

Modello Type	Denti Teeth nr.	Peso Weight kg	Pressione Pressure Max bar	Portata olio Oil flow Lt/min	 Ton.	 Ton.	A mm	B mm	C mm	D mm	E mm	L mm
<b>FOTB S 7</b>	7	285	200	60	1,0-1,8	5,0-8,0	1130	1600	765	1050	520	560
<b>FOTB S 9</b>	9	315	200	60	1,3-1,8	5,0-9,0	1130	1600	765	1050	520	725
<b>FOTB S 11</b>	11	345	200	60	1,5-2,0	6,0-9,0	1130	1600	765	1050	520	885
<b>FOTB S 13</b>	13	375	200	60	1,5-2,0	7,0-10	1130	1600	765	1050	520	1050
<b>FOTB S 15</b>	15	415	200	60	1,5-2,2	10-12	1130	1600	765	1050	520	1210

# FORCHE FP

## I - Forca portapalette

GB - Pallet fork

D - Krangabel

F - Fourche lève - palettes

E - Horquilla porta-pallet



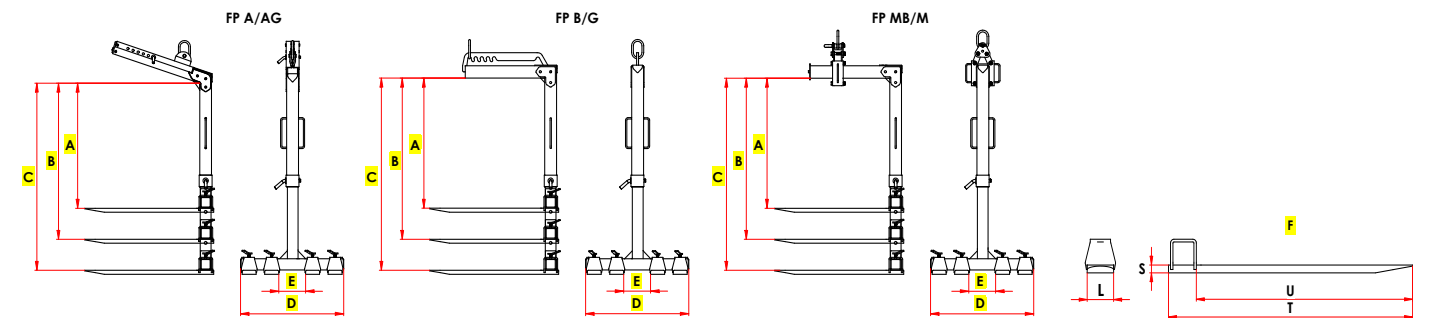

### DISEGNO TECNICO / TECHNICAL DRAWING



 Portata gru a braccio sfilato / Lifting capacity at the end of boom

 Peso escavatore / Excavator weight

Modello Type	Portata Load kg	Peso Weight kg	 Ton.	 Ton.	A mm	B mm	C mm	D mm	E mm	F mm			
										L	S	U	T
<b>FP A 2000</b>	2000	175	1,8-2,5	4,0-7,0	1105	1380	1655	950	270	130	35	1060	1200
<b>FP A 3000</b>	3000	230	2,0-3,0	5,0-8,0	1100	1373	1650	950	270	130	40	1060	1200
<b>FP AG 2000</b>	2000	180	1,8-2,5	4,0-7,0	1640	1915	2190	950	270	130	35	1060	1200
<b>FP B 2000</b>	2000	160	1,8-2,5	4,0-7,0	1150	1425	1700	950	270	130	35	1060	1200
<b>FP B 3000</b>	3000	215	2,0-3,0	5,0-8,0	1150	1425	1700	950	270	130	40	1060	1200
<b>FP G 2000</b>	2000	165	1,8-2,5	4,0-7,0	1610	1885	2160	950	270	130	35	1060	1200
<b>FP G 3000</b>	3000	225	2,0-3,0	5,0-8,0	1610	1885	2160	950	270	130	40	1060	1200
<b>FP MB 2000</b>	2000	165	1,8-2,5	4,0-7,0	1150	1425	1700	950	270	130	35	1060	1200
<b>FP MB 3000</b>	3000	220	2,0-3,0	5,0-8,0	1150	1425	1700	950	270	130	40	1060	1200
<b>FP M 2000</b>	2000	170	1,8-2,5	4,0-7,0	1610	1885	2160	950	270	130	35	1060	1200
<b>FP M 3000</b>	3000	230	2,0-3,0	5,0-8,0	1610	1885	2160	950	270	130	40	1060	1200



# FORCHE FPC

## I - Forca per pareti in cartongesso

GB - Wallboard fork

D - Wendegabel

F - Fourche pivotante pour plaques de plâtre

E - Horquilla para paredes de pladur



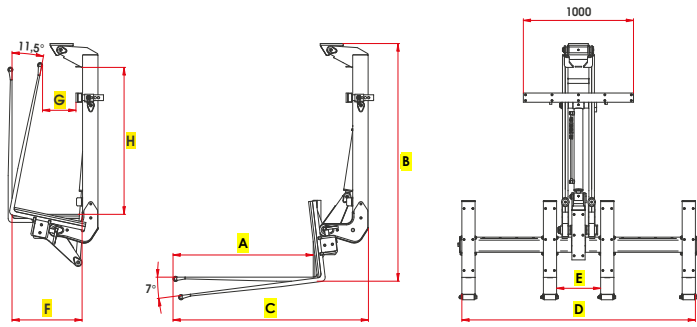

## DISEGNO TECNICO / TECHNICAL DRAWING



Portata gru a braccio sfilato / Lifting capacity at the end of boom



Peso escavatore / Excavator weight

Modello Type	Zanche Tines	Portata Load	Peso Weight	Pressione Pressure	Portata olio Oil flow			A	B	C	D	E	F	G	H
	nr.	kg	kg	Max bar	Lt/min	Ton.	Ton.	mm	mm	mm	mm	mm	mm	mm	mm
FPC46 1500 S	4	1500	480	250	50	1,8-2,5	5,0-9,0	1200	1880	1720	2500	400	480	140	1300
FPC46 2000	2	2000	380	250	50	2,0-3,0	5,0-9,0	1200	1880	1720	2160	400	480	140	1300
FPC65 2000	2	2000	390	250	50	2,0-3,0	5,0-9,0	1200	2060	1720	2160	400	640	330	1300

Hydraulic rotators GR model are the most used, the rotation is 360°, we offer different kind of rotators from 1 to 16 ton depending on Client's needs! They are divided in 2 different kind of rotator: hydraulic rotators with shaft or flanged. Some of our products are designed for a rotator flanged directly on the body while on some others we weld an adaptor that receives the rotor with shaft. For our polyp-grabs we suggest rotators with shaft and double bearings for more resistance.

I rotatori idraulici modello GR sono i più utilizzati, la rotazione è a 360°, offriamo diverse tipologie con portate da 1 a 16 Ton a seconda delle esigenze del cliente! Si distinguono essenzialmente in due categorie: rotatori idraulici con perno oppure flangiati. Alcune nostre attrezzature sono predisposte per avvitare il rotatore con flangia direttamente sul corpo, su altre invece saldiamo un adattatore per ricevere il rotatore con il perno. Consigliamo per le nostre benne a polipo alcuni rotatori con perno e doppio cuscinetto reggispinta per una maggior resistenza.

# ROTATORI

ROTATORS



# ROTATORI MECCANICI

## I - Rotatori meccanici

- GB - Mechanical rotors
- D - Mechanische Drehmotoren
- F - Rotateurs mécaniques
- E - Rotores mecánicos



### DISEGNO TECNICO / TECHNICAL DRAWING

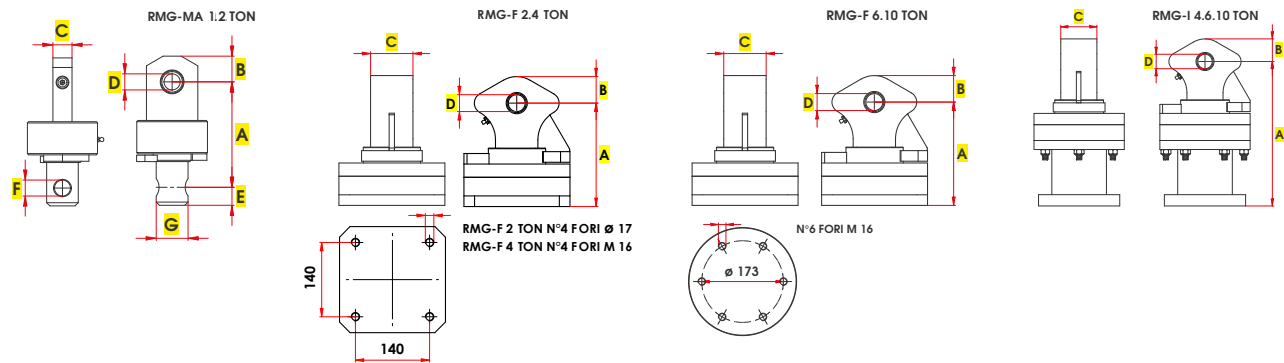

Modello Type	Portata Load	Peso Weight	Rotazione Rotation	A	B	C	D	E	F	G
	kg	kg		mm	mm	mm	mm	mm	mm	mm
RMG-MA	1	7	250°	166	38	30	25	28	25	49,5
RMG-MA	2	17	250°	210	50	60	30	28	30	59
RMG-F	2	19	250°	175	50	60	30	-	-	-
RMG-F	4	33	250°	200	50	80	30	-	-	-
RMG-I	4	40	250°	320	50	80	32	-	-	-
RMG-F	6	42	250°	215	50	80	32	-	-	-
RMG-I	6	53	250°	330	50	80	32	-	-	-
RMG-F	10	90	250°	300	70	100	50	-	-	-
RMG-I	10	108	250°	400	70	100	50	-	-	-

MA = Massello+Albero - Steel lump + shaft  
 F = Flangiato - Flanged  
 I = Incasso - Integrated

# ROTATORI A RALLA

## I - Rotatori a ralla

- GB - Turntable bearings rotors
- D - Lenkkränze Rotatoren
- F - Rotateurs à couronne
- E - Rotores con rangua

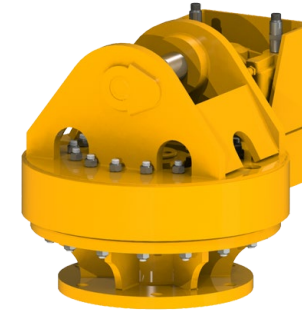

### DISEGNO TECNICO / TECHNICAL DRAWING

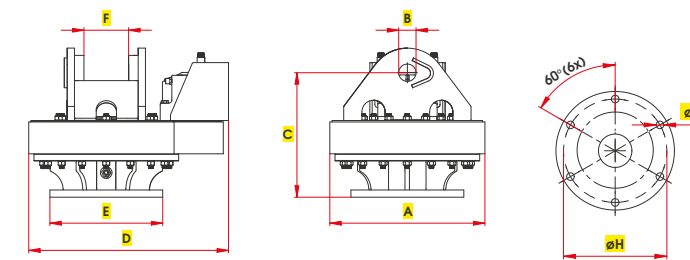

Modello Type	Portata Load	Rotazione Rotation	Peso Weight	Pressure rotation	Pressure Equipment	A	B	C	D	E	F	G	H
	Ton		kg	Max bar	Max bar	mm	mm	mm	mm	mm	mm	mm	mm
RRG 400	8	360°	240	100	250	430	50	380	570	310	125	17	275
RRG 500	16	360°	310	100	250	540	60	430	690	390	154	22	340



# ROTATORI IDRAULICI

## I - Rotatori idraulici

- GB - Hydraulic rotors
- D - Hydraulische Drehmotoren
- F - Rotateurs hydrauliques
- E - Rotores hidráulicos



### DISEGNO TECNICO / TECHNICAL DRAWING

GR 10 - GR 30 B - GR 46- GR 55 M

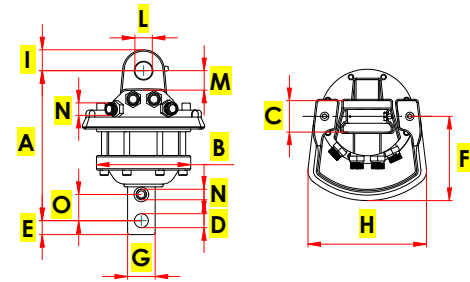

GR 30 PF- GR 465

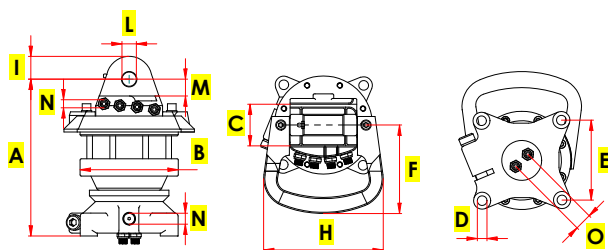

GR 60/69 DB - GR 110-1 DB

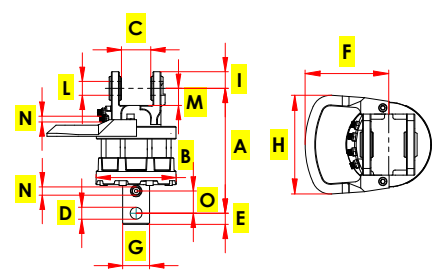

GR 603 DB - GR 104 DB- GR 12 S - GR 16 S

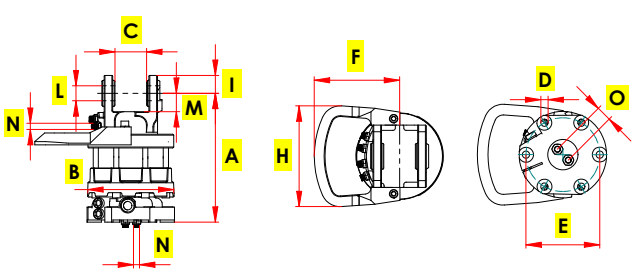

Modello/Type	Portata/Load	Rotation	Peso/Weight	Pressure	A	B	C	D	E	F	G	H	I	L	M	N	O
	Ton		kg	Max bar	mm	mm	mm	mm	mm	mm	mm	mm	mm	mm	mm	mm	mm
GR 10	1	360°	10	250	215	134	45	20	20	125	39,5	182	30	25	34	1/4	40
GR 30 B	3	360°	18	250	249	158	73	25	28,5	155	49,5	210	40	25	36	3/8	48
GR 30 PF	3	360°	24	250	230,5	158	73	17	140	155	-	210	40	25	36	3/8	-
GR 46	4,5	360°	23	250	273	172	73	30	28	155	59	210	40	25	36	3/8	56
GR 465	4,5	360°	27	250	255	172	73	17	140	155	-	210	40	25	36	3/8	30
GR 55 M	5,5	360°	29	250	273	184	73	30	28	174	69	212	40	30	40	3/8	56
GR 60/69 DB	6	360°	37	250	305	198	80,5	30	28	200	69	236	40	35	42	1/2	56
GR 603 DB	6	360°	43	250	297	198	80,5	17	173	200	-	236	40	35	42	1/2	36
GR 110-1 DB	10	360°	50	250	340,5	214	80,5	35	36	199	78	244	45	35	42	1/2	63
GR 104 DB	10	360°	59	250	331,5	214	80,5	17	173	200	-	244	45	35	42	1/2	40
GR 12 S	12	360°	70	250	362	224	100,5	17	173	199	-	249	55	45	58	1/2	40
GR 16 S	16	360°	71	250	375	224	100,5	17	173	199	-	249	55	45	58	1/2	40

# ROTATORI A PISTONI RADIALI

## I - Rotatori a piston radiali con grande capacità di carico assiale

- GB - Hydraulic radial pistons rotors with great axial capacity
- D - Hydraulische Radial-Drehmotoren mit großer Axialbelastung
- F - Rotateurs hydrauliques à pistons radiaux avec grande capacité de charge axiale
- E - Rotores hidráulicos a pistones radiales con gran capacidad de carga axial



# ROTATORI A PISTONI COMPATTI

## I - Rotatori idraulici compatti a piston radiali

- GB - Compact hydraulic radial pistons rotors
- D - Kompakte hydraulische Radialantriebe Drehmotoren
- F - Rotateurs hydrauliques compacts à pistons radiaux
- E - Rotores hidráulicos compactos a pistones radiales





# ATTACCO SOSPENSIONE

I- L'attacco di sospensione è uno snodo di collegamento tra l'attrezzatura e il braccio della gru/escavatore

GB - Suspension link is a joint connection between the equipment and the arm of the crane/excavator

D - Die Aufhängung ist ein Kreuzpendel zwischen dem Gerät und dem Arm des Krans / Bagger.

F - L'attache de suspension est une connexion entre le dispositif et le bras de la grue / pelle.

E - El ataque de suspensión es una conexión de unión entre el dispositivo y el brazo de la grúa / excavadora

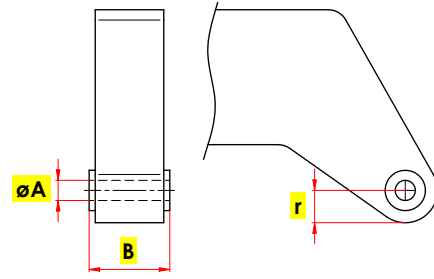

ØA	B	r

TERMINALE ESCAVATORE / EXCAVATOR BOOM

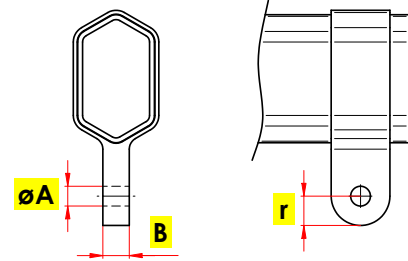

ØA	B	r

TERMINALE GRU MASCHIO / MALE BOOM TYPE

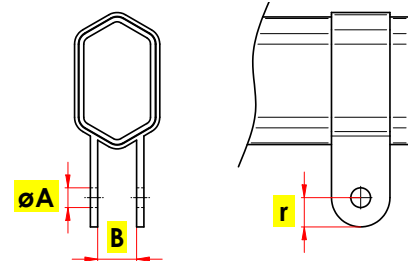
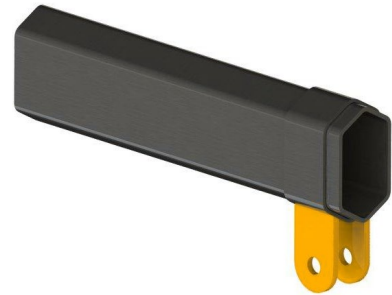

ØA	B	r

TERMINALE GRU FEMMINA / FEMALE BOOM TYPE





# ITALIAN MANUFACTURING



